

Combustion of Coal

Combustion is a rapid chemical reaction between fuel and oxygen. When combustible elements of fuel combine with O_2 , heat energy comes out.

During combustion combustible elements like Carbon, Sulfur, Hydrogen etc combine with oxygen and produce respective oxides.

The source of oxygen in fuel combustion is air. By volume there is 21% of Oxygen presents in air and by weight it is 23.2%. Although there is 79% (by volume) nitrogen in air but it plays no role in combustion.

Actually Nitrogen carries heat produced during combustion to steam boiler stack.

As per **combustion theory** the quantity of air required for combustion is that which provides sufficient O_2 to completely oxidize combustible elements of fuel.

This quantity of air is normally known as **STOICHIOMETRIC AIR** requirement.

Different types of coal combustion techniques

Combustion of Coal

Combustion may be defined as the rapid high temperature complicated chemical reaction of oxygen with carbon, hydrogen and sulphur of coal.

These reactions follow mainly four steps

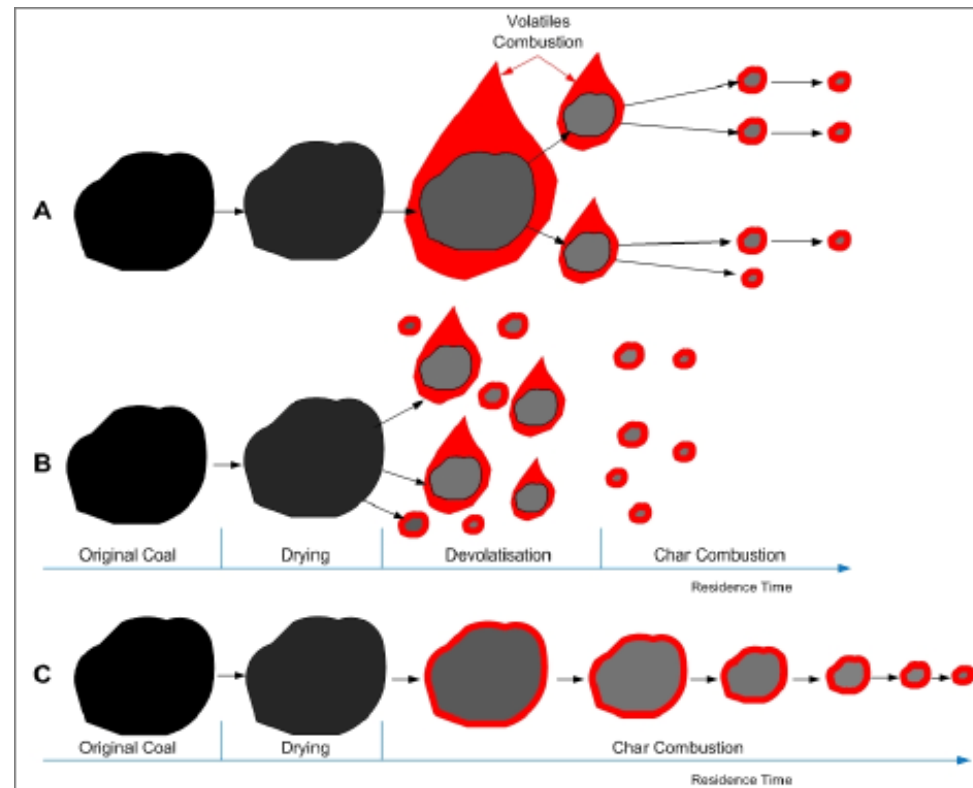

1. Formation of coal-oxygen complexes with evolution of heat.
2. Decomposition of these complexes with the generation of CO_2 and H_2O molecules and formation of carboxyl (COOH), carbonyl (C=O) and phenolic $-\text{OH}$ groups along with more heat generation.
3. Decomposition of these groups to produce CO , CO_2 , H_2 , H_2O and hydrocarbons such as ethane, ethylene, propylene etc.
4. Decomposition of aliphatic structure (relating to or denoting organic compounds in which carbon atoms form open chains (as in the alkanes), not aromatic rings.) with the formation of CO , CO_2 and H_2O .

In low temperatures, the first step is developed faster than others.

Oxygen molecules are diffused through the pores into the internal surface and are attached to the coal surface by physical adsorption.

In this stage, the oxide layer formed due to the exposure of coal surface to the air, prevents the diffusion of oxygen partially and oxidation rate is decreased with time. The reactions between oxygen and coal are exothermic.

The reaction rate increases as the temperature increases and as a result coal reaches to ignition temperature at about 175°C with the firing of a flame.

The time required from the beginning of oxidation to reach the ignition temperature is called incubation period.

Ignition point is the temperature at which the temperature of the combustible material should be reached before it is combined with oxygen and combustion takes place.

For complete combustion to take place, sufficient time must be allowed before the temperature of the gases is lowered below that point.

Mechanism of Combustion

A combustion reaction has a particular speed at a specified temperature. In many cases, the mechanism of combustion follows the complex kinetics phenomena with several elementary steps.

In the preliminary study, the possible steps on the overall reaction are to be assumed.

For kinetically controlled reactions, a large number of elementary reaction steps involving large number of intermediates are possible and it is very difficult to formulate the overall rate equation.

For example, a large number of species are involved in the combustion of simple hydrocarbons.

The combustion can be explained by radical mechanism usually consisting of

initiation,
propagation,
branching and
termination.

Initiation:



Chain propagation:

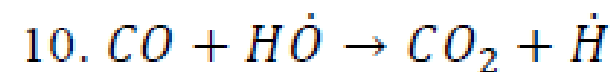
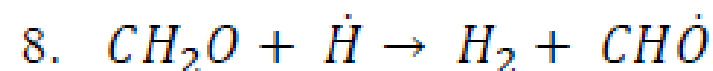
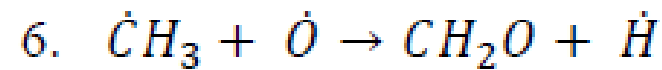
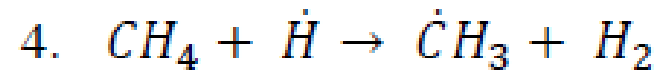

Branching :

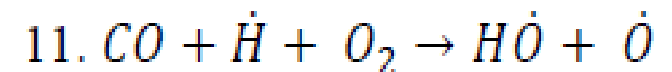

Termination:



In complete combustion, the carbon combines with an equivalent amount of oxygen to form CO_2 .

Incomplete combustion occurs when coal does not unite according to the reaction stoichiometry.

In this type of combustion carbon monoxide, CO , may be formed which may be burned to carbon dioxide by the reaction with more oxygen.

The hydrogen and oxygen combine to produce H_2O vapour.

Sulphur is converted to SO_2 , which in dissolution with water forms sulphuric acid

It is clear that the amount of oxygen required for the combustion of a definite species or compound is fixed.

Calorific value of each combustible substance is unique for it.

In practice it is impossible to obtain complete combustion with the theoretical amount of air.

In most of the cases, excess, amounting to double or more than the theoretical supply of oxygen is required, depending upon the nature of the fuel to be burned and the method of burning it.

The reason for this is that it is impossible to bring each molecule of oxygen in the air into intimate contact with the particles in the fuel that are to be oxidized.

If less than this amount of air is supplied, the carbon burns to carbon monoxide instead of dioxide and its heat as complete combustion is not obtained.

Coal Combustion Technology

The technology of the combustion of coal mainly depends on the type of coal firing equipment, coal-feeding method and the type of combustion devices, such as fixed-bed combustion, fluidized-bed combustion, and coal suspended-bed.

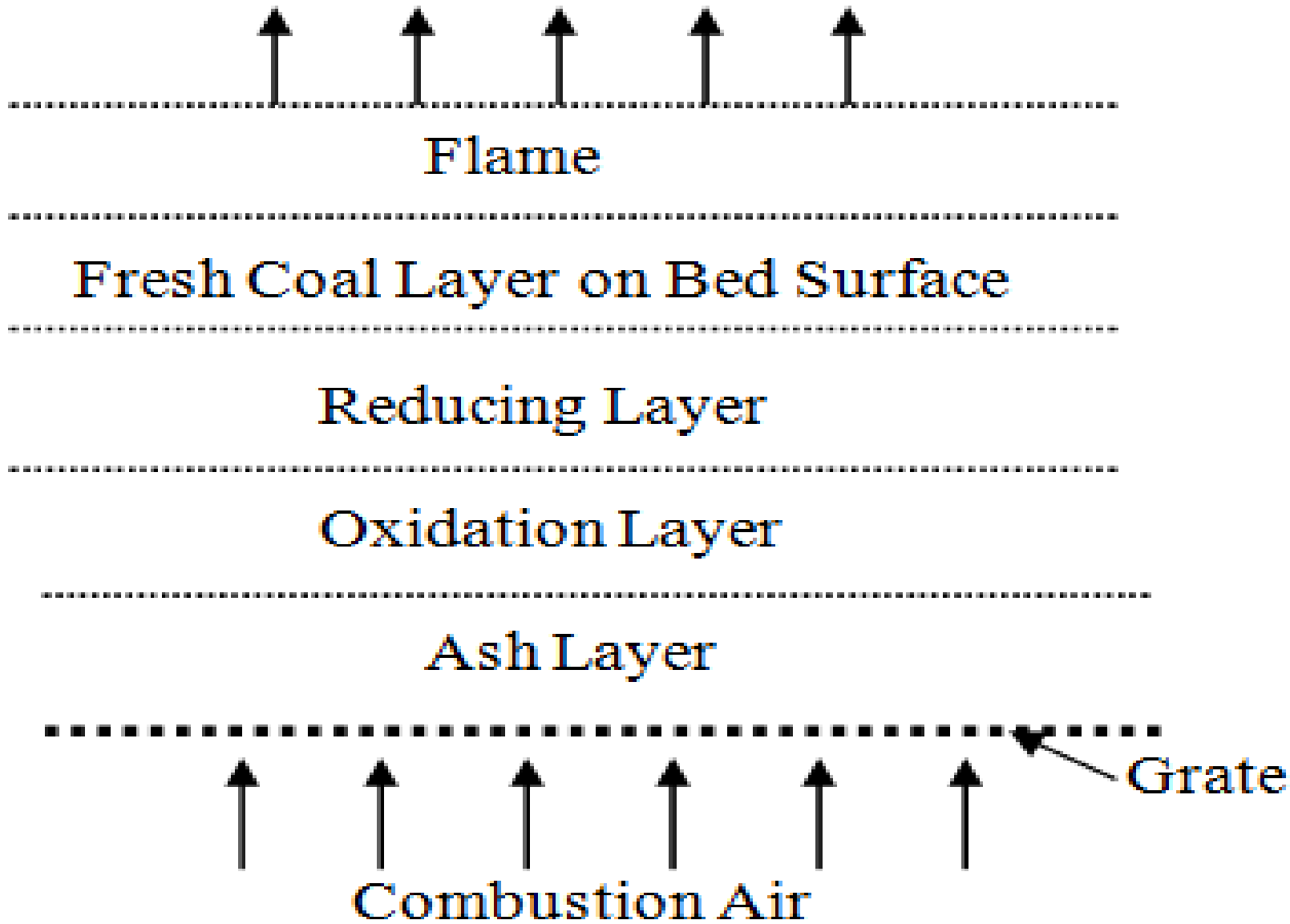

Fixed grate overfeed
combustion

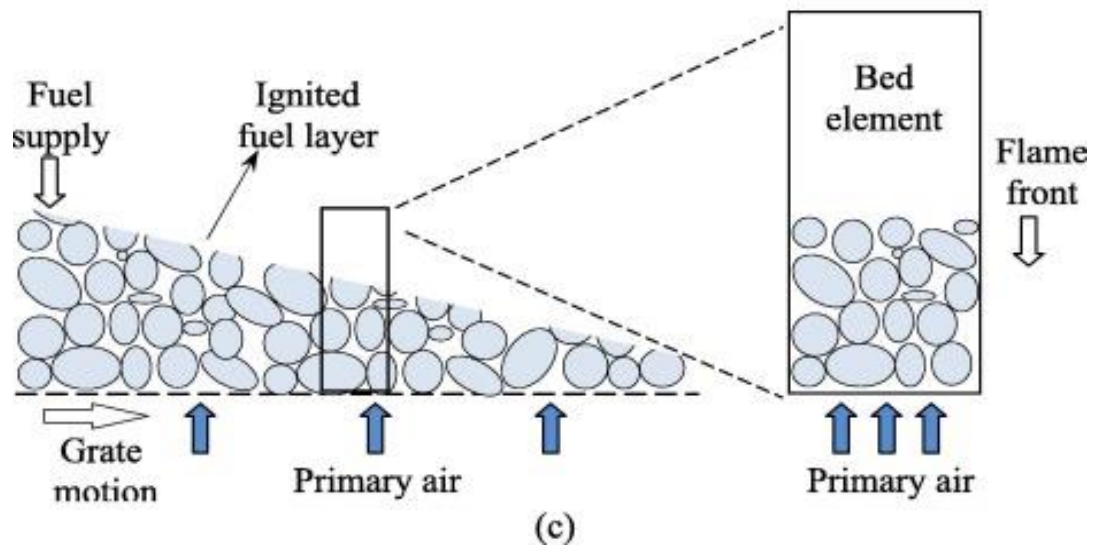
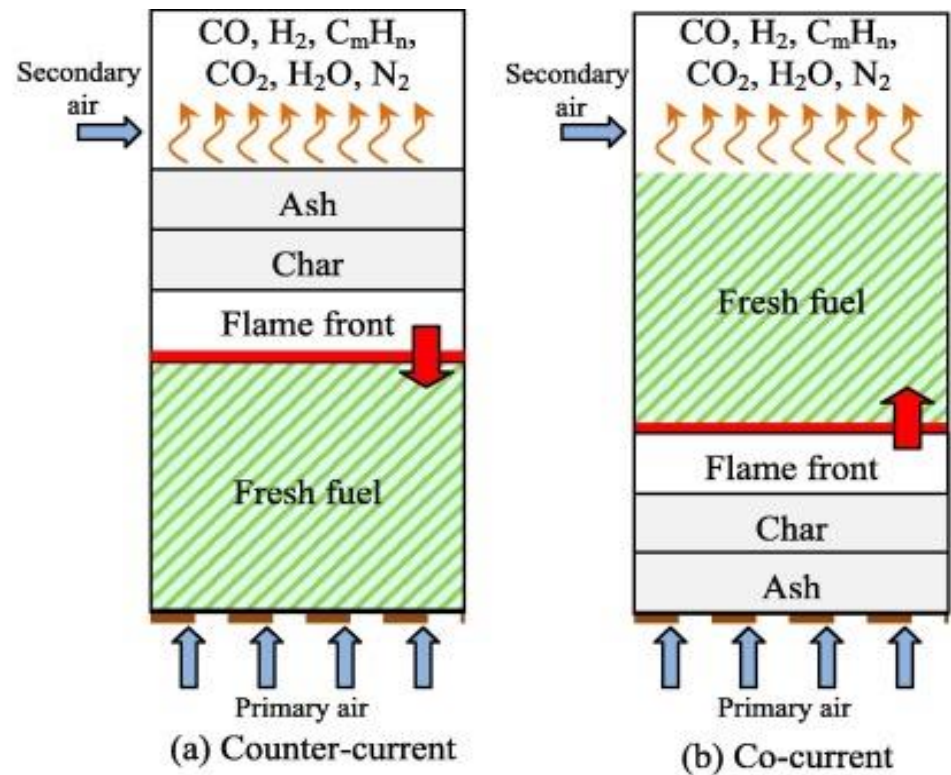

Fixed Bed Combustion: In fixed bed, coal particles are supported on a grate in the combustion chamber. The combustion air is allowed to flow through the coal bed in upward direction either by a chimney draft or by a fan.

Coal may be fed to the bed in different ways as **over-feed, under feed or cross-feed.**

The grate may be fixed or movable. In case of **overfeed technique**, the fresh coal particles are spread over the bed. The different combustion reactions may take place in different combustion zone starting from grate to bed surface.

The combustion air passes through the grate and moves upward.

This becomes heated in the hot ash layer and the combustion takes place in the coal-char with the formation of carbon dioxide.

This reaction is highly exothermic and generates heat.

The bed-temperature rises rapidly in this zone and the oxidation reaction occurs rapidly.

Depending on the thickness of the bed, two different types of combustion chamber may be constructed,

either shallow-bed or
thick-bed.

The air is supplied from the bottom as well at top of the bed in both upward and downward respectively.

Air supplied from the bottom is called the primary air (Co current)and the air supplied at the top is called the secondary air(counter current), which is required to burn out the combustible gases.

Coal may be fed under the bed. This is known as **underfeed technique**.

The burning coal moves in **cross current** with respect to the flow of combustion air.

The volatile matters, moisture and combustion air pass through the bed with the formation of less smoke. Air is supplied by a fan.

Fluidized bed combustion

If air is passed upward through a bed of solid particles, the bed of particles remains stationary at low velocity.

As the air velocity is increases, the particles become suspended in the air stream.

At a particular air velocity, the particles behave just like a boiling fluid. **Under this condition, the bed is called fluidized bed.**

If the air velocity is further increased, there will be bubbling fluidized bed with the flow of air bubbles.

At a certain higher velocity, the particles are blown out of the bed.

The particles can be recycled by mixing with the air feed. **Then the bed is called circulating fluidized bed.**

In a fluidized bed combustion, sand particles may be used as heating medium.

The sand particles are first fluidized state and heated to reach the ignition temperatures of coal at about 900°C .

Then coal is injected into the bed and burnt.

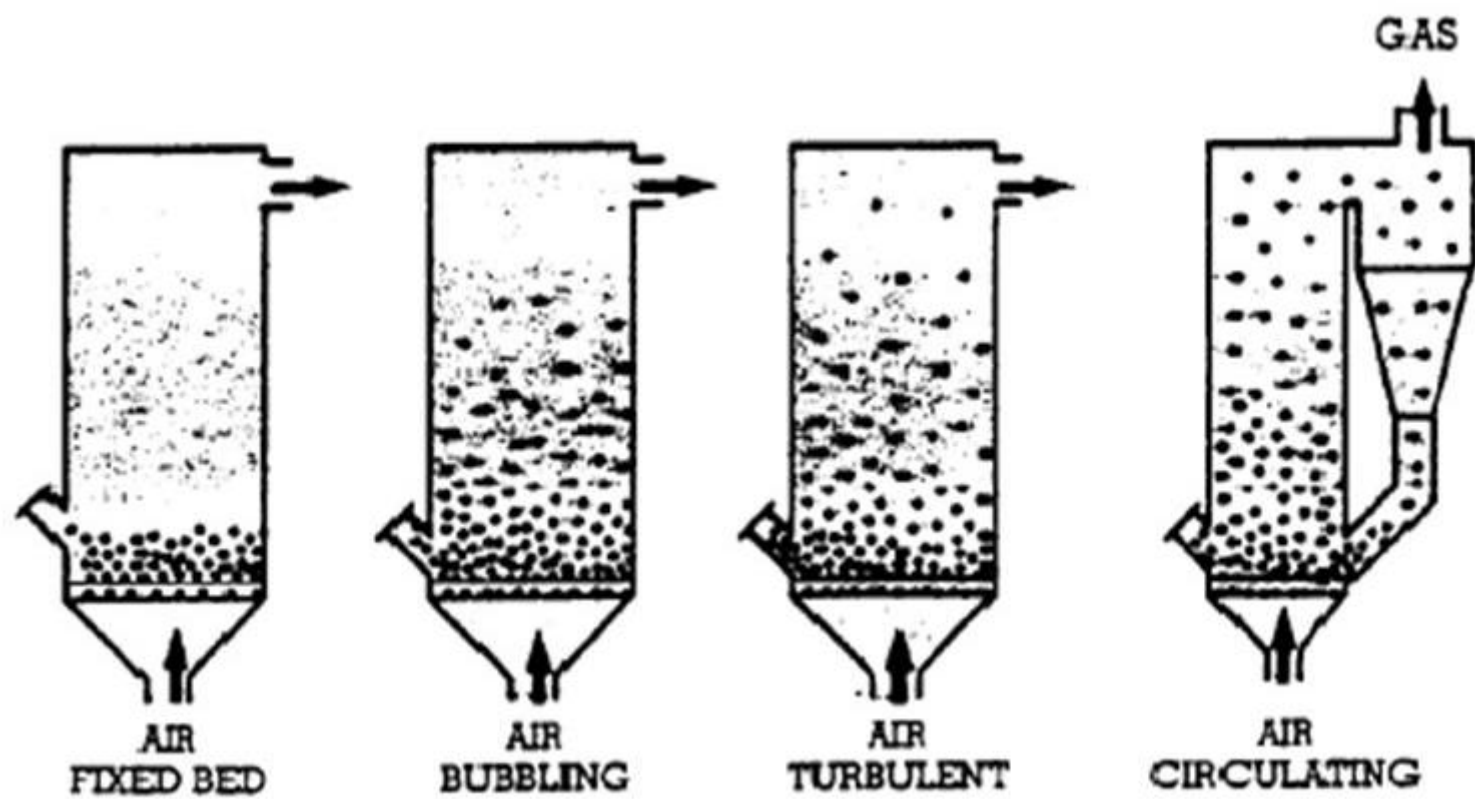

A bed of solid particles is said to be fluidized when the pressurized fluid (liquid or gas) is passed through the medium and causes the solid particles to behave like a fluid under certain conditions.

Fluidization causes the transformation of the state of solid particles from static to dynamic.

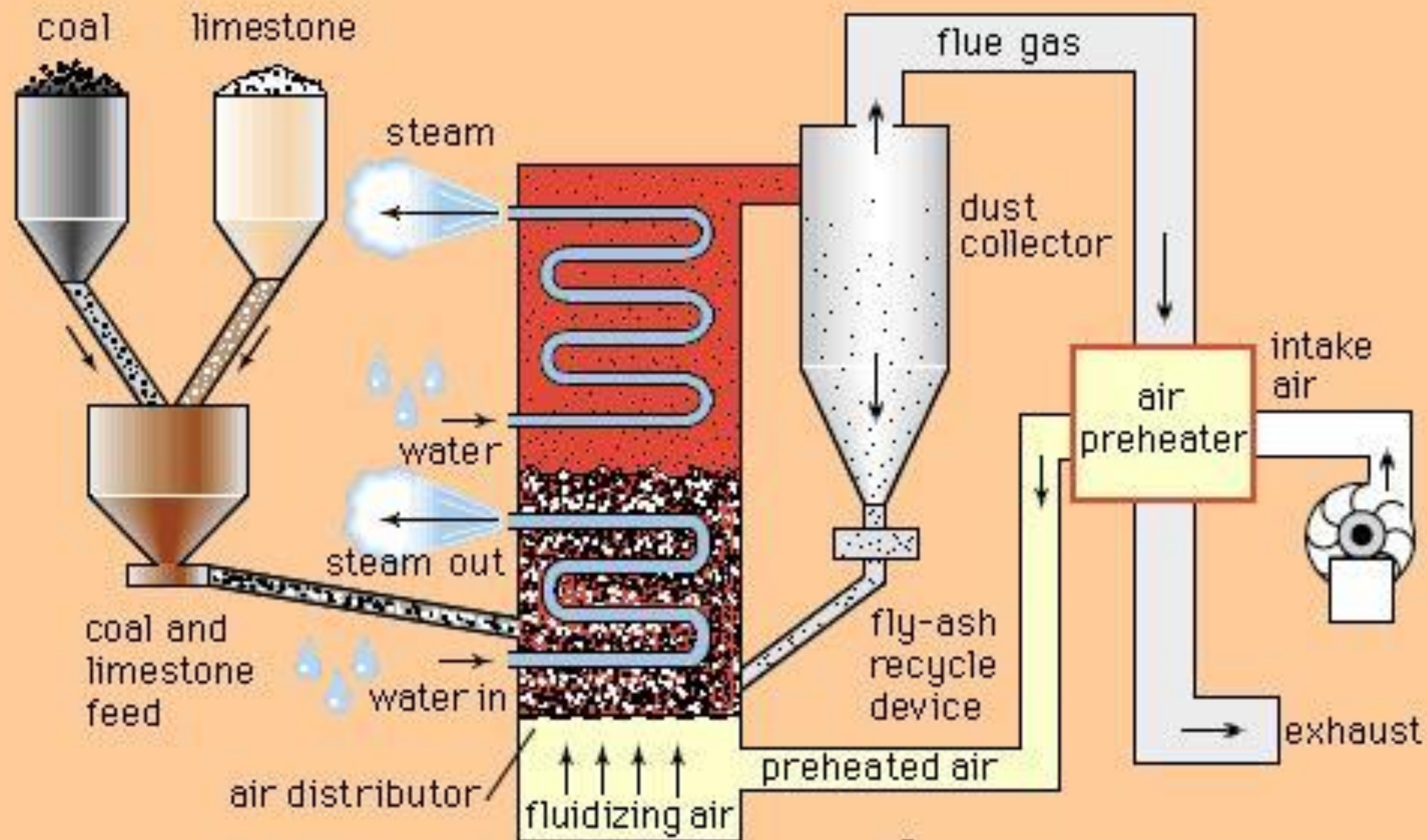

FBC systems fit into essentially two major groups,
atmospheric systems (FBC)
and pressurized systems (PFBC),

and two minor subgroups,
bubbling (BFB) and
circulating fluidized bed (CFB).

FBC

Atmospheric fluidized beds use limestone or dolomite to capture sulfur released by the combustion of coal. Jets of air suspend the mixture of sorbent and burning coal during combustion, converting the mixture into a suspension of red-hot particles that flow like a fluid. These boilers operate at atmospheric pressure.

PFBC

The first-generation PFBC system also uses a sorbent and jets of air to suspend the mixture of sorbent and burning coal during combustion. However, these systems operate at elevated pressures and produce a high-pressure gas stream at temperatures that can drive a gas turbine. Steam generated from the heat in the fluidized bed is sent to a steam turbine, creating a highly efficient combined cycle system.

In fluidised bed combustion, coal is crushed to a size of 1 – 10 mm depending on the rank of coal, type of fuel feed and fed into the combustion chamber.

The atmospheric air, which acts as both the fluidization air and combustion air, is delivered at a pressure and flows through the bed after being preheated by the exhaust flue gases.

The velocity of fluidising air is in the range of 1.2 to 3.7 m/sec. The rate at which air is blown through the bed determines the amount of fuel that can be reached.

Oxy-Fuel combustion

Oxy-fuel combustion is a pulverized coal combustion process practiced in coal-fired power plant.

In a traditional power plant, the pulverized coal used for fuel is fired and the oxygen comes from injected air.

Pulverised coal combustion technology is mainly used for steam generation in the power plant, where most of the cases suspended coal bed is employed. In combustion oxygen may be supplied by using fresh air or a stream rich in oxygen to ensure complete combustion. Oxy fuel combustion is an example of a process where the second type of oxygen supply is utilised.

In oxy-fuel combustion, oxygen-enriched gas mix is used instead of air (about 95% oxygen).

The use of higher concentration of oxygen results in a very high flame temperature in the boiler.

Sometimes, the enriched oxygen stream with recycled flue gas (RFG) is used.

This also may decrease the flame temperature to a level similar to that of a conventional air-fired boiler. But the justification for using oxy-fuel is that it produces a CO₂ flue gas.

The use of fluidized bed combustion is advantageous over the traditional firing system as it has simpler boiler design, higher combustion efficiency and reduced pollution problems.

The advantages of FBC are they produce less NO_x in the outlet gas, because of lower combustion temperatures, and they produce less SO_x when limestone is continuously added with the coal. They can also use a wider range of fuels than PF combustion.

- 1.FBC has a lower combustion temperature of 750 °C whereas an ordinary boiler operates at 850 °C.
- 2.FBC has low sintering process (melting of Ash).
- 3.Lower production of NO_x due to lower temperature.
- 4.Lower production of SO_x due to capture by limestone.
- 5.Higher combustion efficiency due to 10 times more heat transfer than other combustion processes because of burning particle.
- 6.Less area is required for FBC due to high coefficient of convective heat transfer.
- 7.Iso-thermal bed combustion as temperature in free belt and active belt remain constant.

COKE PRODUCTION

The cokemaking process involves carbonization of coal to high temperatures (1100°C) in an oxygen deficient atmosphere in order to concentrate the carbon.

The commercial cokemaking process can be broken down into two categories: **a) By-product Cokemaking and b) Non-Recovery/Heat Recovery Cokemaking.**

The majority of coke produced comes from wet-charge, by-product coke oven batteries.

The entire cokemaking operation is comprised of the following steps:

Before carbonization, the selected coals from specific mines are blended, pulverized, and oiled for proper bulk density control.

The blended coal is charged into a number of slot type ovens wherein each oven shares a common heating flue with the adjacent oven.

Coal is carbonized in a reducing atmosphere and the off-gas is collected and sent to the by-product plant where various by-products are recovered. Hence, this process is called by-product cokemaking.

The coal-to-coke transformation takes place as follows:

The heat is transferred from the heated brick walls into the coal charge. From about 375°C to 475°C, the coal decomposes to form plastic layers near each wall.

At about 475°C to 600°C, there is a marked evolution of tar, and aromatic hydrocarbon compounds, followed by resolidification of the plastic mass into semi-coke.

At 600°C to 1100°C, the coke stabilization phase begins.

This is characterized by contraction of coke mass, structural development of coke and final hydrogen evolution.

During the plastic stage, the plastic layers move from each wall towards the center of the oven trapping the liberated gas and creating in gas pressure build up which is transferred to the heating wall

Once, the plastic layers have met at the center of the oven, the entire mass has been carbonized.

The coke mass is pushed from the oven and is wet or dry quenched prior to its shipment to the blast furnace.

b) Non-Recovery/Heat Recovery Coke Production:

In Non-Recovery coke plants, originally referred to as beehive ovens, the coal is carbonized in large oven chambers.

Primary air for combustion is introduced into the oven chamber through several ports located above the charge level in both pusher and coke side doors of the oven.

Partially combusted gases exit the top chamber through "down comer" passages in the oven wall and enter the sole flue, thereby heating the sole of the oven.

Combusted gases collect in a common tunnel and exit via a stack which creates a natural draft in the oven.

Since the by-products are not recovered, the process is called Non-Recovery cokemaking.

In one case, the waste gas exits into a waste heat recovery boiler which converts the excess heat into steam for power generation; hence, the process is called Heat Recovery coke making.

a) Physical Properties:

Measurement of physical properties aid in determining coke behavior both inside and outside the blast furnace. In terms of coke strength, the **coke stability and Coke Strength After Reaction with CO₂ (CSR)** are the most important parameters.

The **stability measures** the ability of coke to withstand breakage at room temperature and reflects coke behavior outside the blast furnace and in the upper part of the blast furnace.

CSR measures the potential of the coke to break into smaller size under a high temperature CO/CO₂ environment that exists throughout the lower two-thirds of the blast furnace

FACTORS AFFECTING COKE QUALITY

A good quality coke is generally made from carbonization of good quality coking coals.

Coking coals are defined as those coals that on carbonization pass through softening, swelling, and resolidification to coke.

The properties of coke and coke oven performance are influenced by following coal quality and battery operating variables:

- 1) rank of coal,
- 2) Chemical and rheologic characteristics of coal,
- 3) particle size,
- 4) moisture content,
- 5) bulk density,
- 6) weathering of coal,
- 7) coking temperature and coking rate,
- 8) soaking time,
- 9) quenching practice, and
- 10) coke handling.

Liquid fuel

Petroleum is the naturally occurring liquid fuel and it accounts for the bulk of the liquid fuels.

Petroleum can be defined as a mixture of gaseous, liquid and solid hydrocarbons or hydrocarbon derivatives that occur naturally within the geological traps.

It is generally agreed that petroleum was formed by processes similar to those which yielded coal, but was derived from small animals, mainly marine animals.

Bacteria were usually present and helped to remove oxygen from the molecule, which were mostly carbohydrates, comprising of carbon, hydrogen and oxygen.

These carbohydrate molecules were turned into hydrocarbons by the bacterial action.

High pressure of the overlying rock layers forced the oil to migrate from compacted mud layer (shale) to less compacted limestone, dolomite, sandstone layers.

The first type of rocks (sedimentary rocks) has lesser permeability than the second type (reservoir rocks).

Reservoir rock must possess fluid holding capacity and also fluid transmitting capacity.

Cap rock act as a seal to prevent the escape of oil and gas from the reservoir rock.

Typical cap rocks are clays and shells, rocks in which the pores are very much finer than those of reservoir rock.

It also has far lower permeability than reservoir rock.

Salts, anhydrites, gypsum which are called evaporates also act as cap rock.

The structures of reservoir rocks are of different types, such as, anticline, syncline, folds, faults, fractures, unconformities etc

The two essential properties of reservoir rock are porosity and permeability. **Porosity is the storage capacity of the rock.** This is sometimes expressed as porosity (%-void ratio) as

$$\text{Porosity (\%)} = \frac{\text{Void volume}}{\text{Rock volume}} \times 100$$

Permeability is the rate of flow of fluid through the rock.

It is expressed by Darcy's law which states that the rate of flow of a homogeneous fluid in a porous medium is proportional to the pressure gradient and inversely proportional to the fluid viscosity.

Permeability is expressed in Darcies (D). As most of the petroleum reservoirs have permeability less than 1D, hence millidarcy (1/1000 D) is usually used.

For petroleum oil exploration, the knowledge of underground structures is necessary.

The properties which are encountered in gaining the data are **density, elasticity, magnetic and electrical properties of rocks.**

All these data collectively gives the idea of occurrence and commercial exploration of crude petroleum at a definite reserve.

The principle of obtaining those data mainly depends on the use of **magnetism, gravity and sound waves** and the respective instruments used are, **magnetometer, gravimeter and seismograph.**

Magnetometer

Magnetometer is a specially designed instrument which can detect minute differences in the magnetic properties of various rock structures, which helps to find out the formations that might contain oil.

Except this, magnetometer provides the clue about the depth of basement rock, the probability of finding the locations having oil-favourable structures.

Gravimeter

Gravimeter detects differences in the gravity pull between the normal gravity and the gravity of a subsurface structural formation.

This gives the indication of the location and density of underground rock formations.

Seismograph

Seismograph works on measuring the shock waves obtained from explosions initiated by triggering small controlled charges of explosions in the bottom of the shallow holes in the ground.

The acoustic waves travel outwardly in all directions and some are reflected back to the ground surface by denser rock formations below.

The formation depth is determined by measuring the time elapsed between the explosion and detection of the reflected wave at the surface.

Accumulation of petroleum in sediments

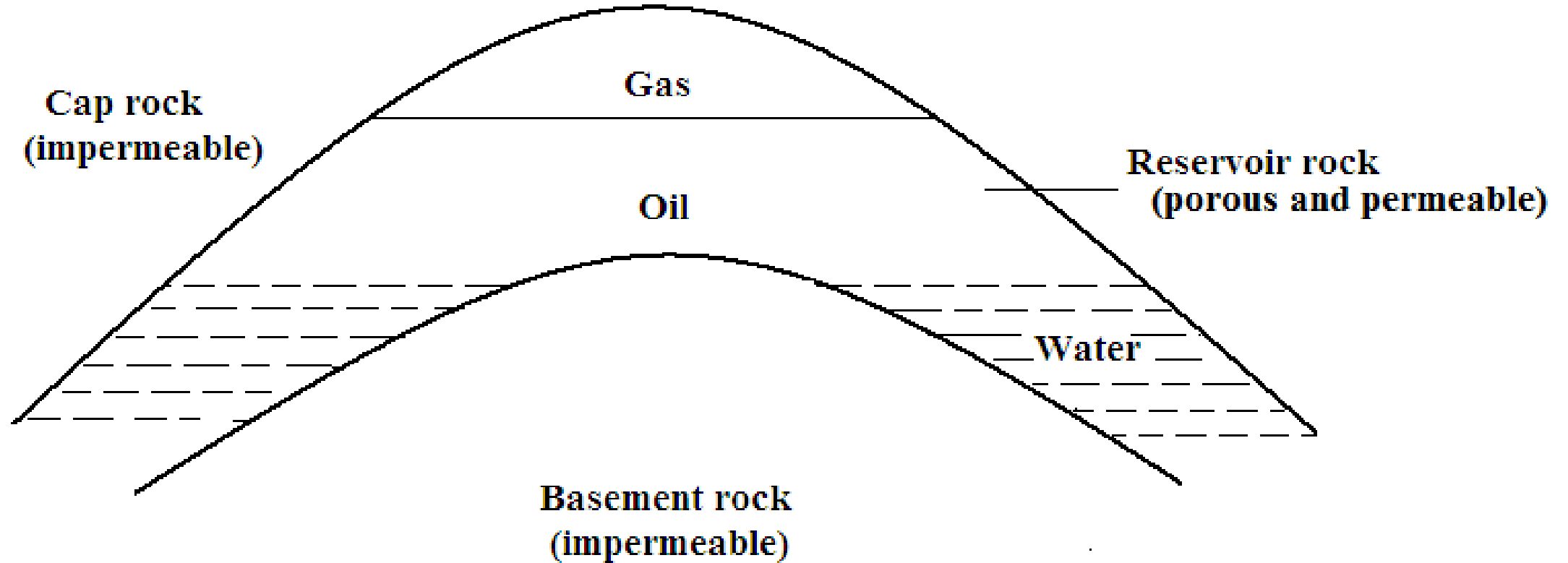

Accumulation of gas, oil and water in a dome-shaped reservoir rock

Accumulation of petroleum in sediments

- Reservoir rock must possess fluid holding capacity and also fluid transmitting capacity.
- Most reservoir rocks are coarser grained sedimentary rocks.
- Cap rock act as a seal to prevent the escape of oil and gas from the reservoir rock.
- Typical cap rocks are clays and shales, rocks in which the pores are very much finer than those of reservoir rock.
- It also has far lower permeability than reservoir rock.
- Salts, anhydrites, gypsum which are called evaporates also act as cap rock.

- Once formed, the sedimentary rocks are subjected to various kinds of deformation, such as folding and faulting.
- Circular upfolds in the rocks are called “domes”.
- More or less circular depressions in the layered rocks are called “basins”.

- The distribution of fluids in a reservoir rock is dependent on **densities of the fluids and the detailed capillary properties of the rock.**
- Taking the simplest case of a rock in which pores are uniform size and evenly distributed, the fluids are distributed in the **order, gas, oil, brine water in the ascending order of density.**
- The upper zone of the rock pores are filled **mainly by gas (gas cap), a middle zone, which is occupied mainly by oil** with gas in solution and a **lower zone, filled by water.**

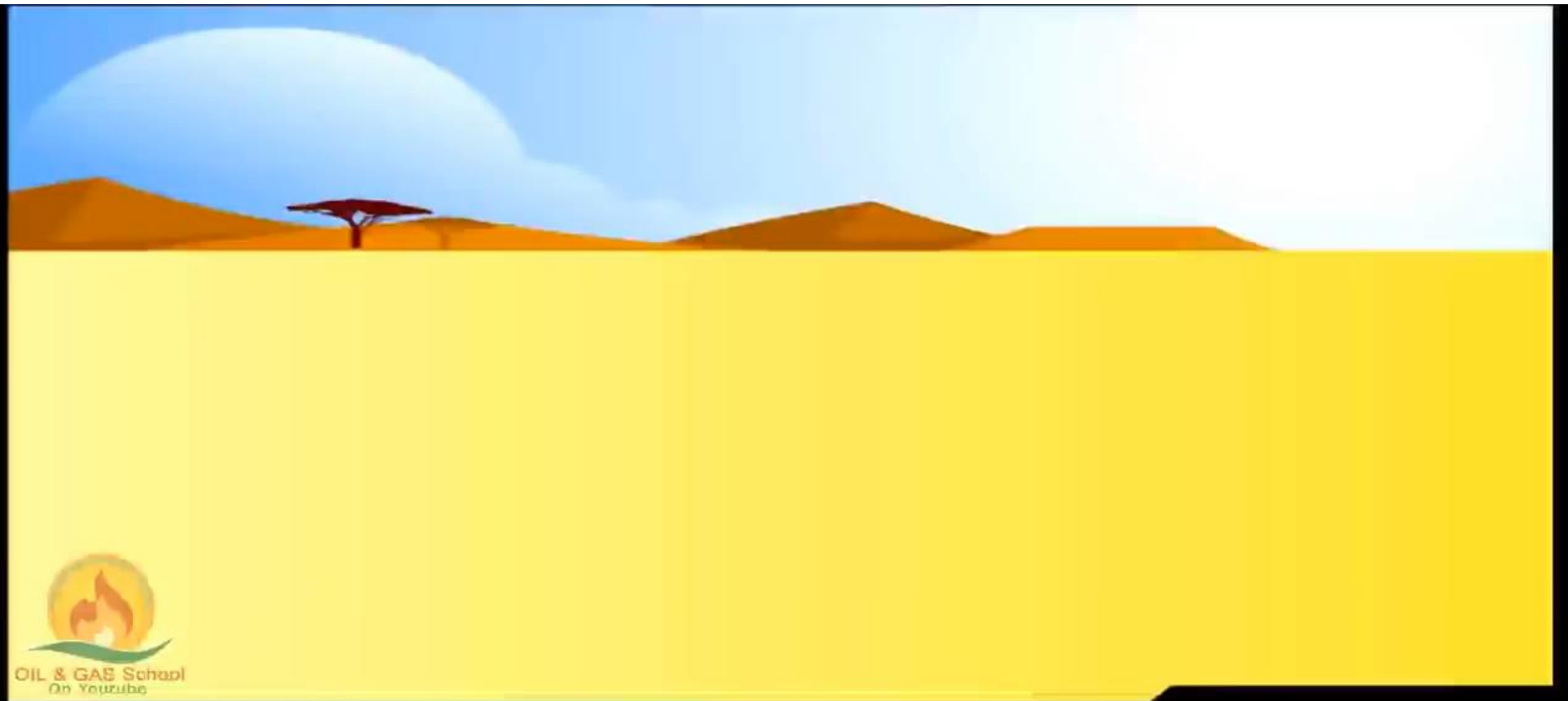

■ THE HYPOTHESES

Geologists and geophysicists have agreed on the existence of a "prospect", a potential field. In order to find out if hydrocarbons are indeed trapped in the reservoir rock, we must drill to hit them.



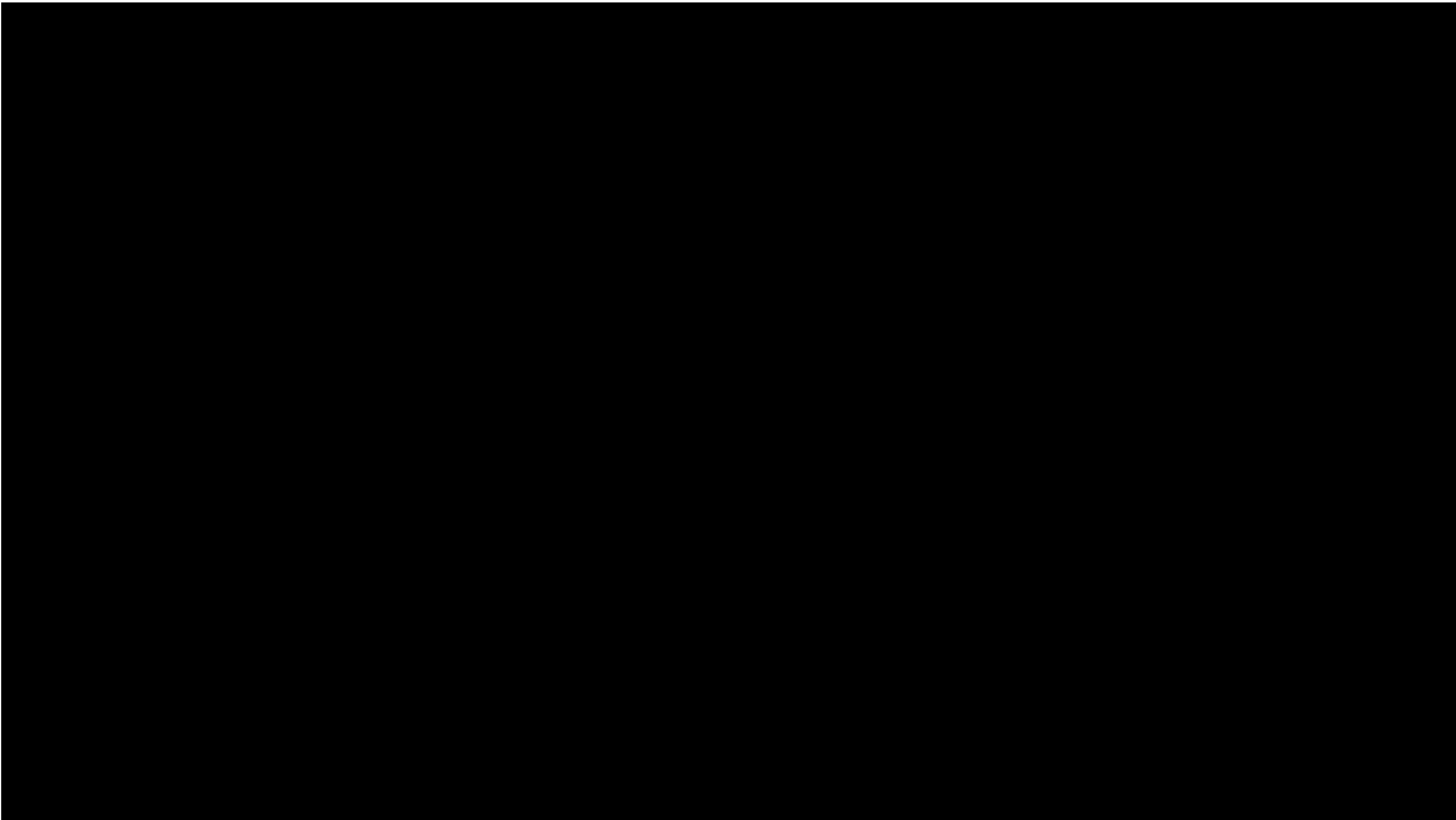

Drilling operation

The exploration and drilling processes are planned in such a way so that the whole process becomes safe and cost-effective.

The wells drilled in these reservoirs may be onshore or offshore.

The depth of the well may vary from 1000 to 30,000 ft and wells may be drilled either totally vertically or in many cases a larger part of the well may be drilled in inclined or horizontal manner.

Most of the drilling operation is done by rotary method in which an abrasive bit is revolved at the end of a drilling stem or drill string.

Generally, almost all drilling rigs (the assembly which is used for drilling) are composed of the components: **a power plant, hoisting and rotary machinery, the drill column, a mud circulation system and auxiliaries.**

The power used for drilling may vary from 250 to 2000 bhp (1491.33 kw), a heavy duty mud pump needs around 700 bhp.

Hoisting system is a large pulley system which is used to run and pull the equipments (drill string and casing) into and out of the well.

Rotary system is used to rotate the drill string and therefore the drill bit, on the bottom of the borehole.

The casing provides a permanent wall to the borehole, prevents cave-in, blocks off unwanted water, oil or gas from another formation, provides a return passage for the mud stream and provides control of the well during production.

The mud circulating system is used to circulate the drilling fluid or mud down the drill string, up the drill string to the borehole annulus and for carrying the drill cuttings from the mouth of the bit to the surface.

Drilling fluid is usually a mixture of water, clay (bentonite), weighing material (barite) and chemicals.

The mud is mixed and conditioned in the mud pits and then circulated downhole by large pumps.

The major functions of drilling fluid are

1. To cool and lubricate the drilling bit and the drill string.
2. To remove drilled solids, allowing their release at the surface.
3. To form a gel to suspend drilled cuttings and any weighing materials, when the fluid column is static.
4. To control subsurface pressure.
5. To prevent squeezing or caving of formations and to plaster the sides of the borehole.

Recovery of oil when a well is first opened is generally by **natural flow, forced by the pressure of the gas or fluids that are contained within the reservoir.**

At the beginning, there may be a chance of flush, hence at this stage, well should be carefully controlled.

There are several ways which serve to drive out the petroleum fluids from the formation to the surface, through the well.

These drives are classified as either **natural flow (Primary recovery) or applied flow (Improved oil recovery).**

Natural drive or Primary recovery

Petroleum is propelled out of the reservoir through the well by one of the three methods, or combinations of those,

- a) dissolved gas drive,
- b) gas-cap drive,
- c) water drive.

In dissolved gas drive, the gas dissolved in petroleum oil exerts force to propel the oil as it tends to come out of the solution because of the release of pressure at the point of drilling.

Dissolved gas drive is the least efficient method of natural drive as it is difficult to control the gas-oil ratio, rapid drop in the bottom hole pressure and the recovery may be less than 20%.

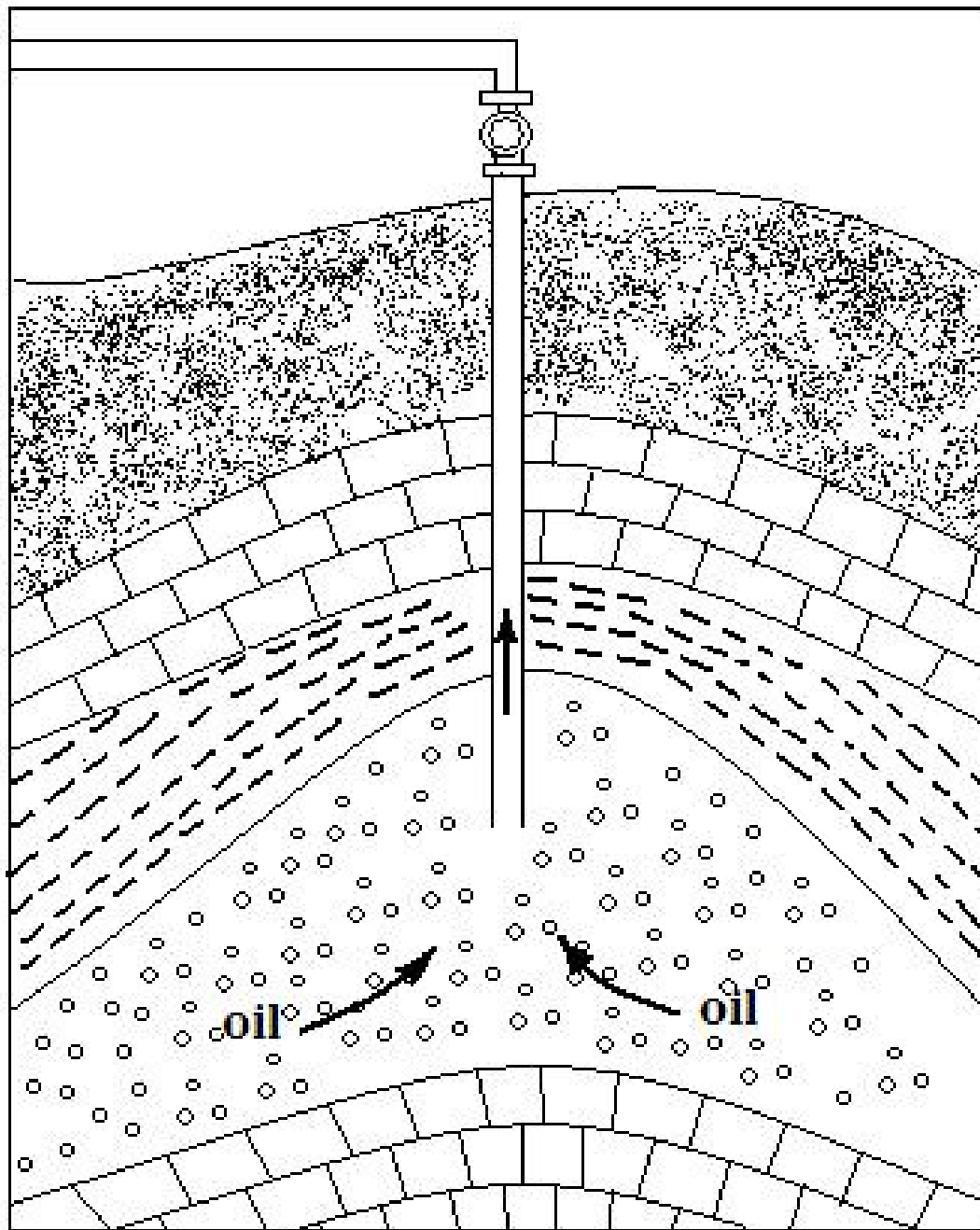

In gas- cap drive compressed gas is utilized to drive the oil into the well.

Normally the gas-cap contains methane and other hydrocarbon gases, which may be separated from the oil after the recovery, by compressing the gas.

Natural gasoline is a well known example of the recovered compressed hydrocarbon, which was formerly known as natural gas-gasoline.

The normal percentage recovery in a gas cap drive is 40 to 50%.

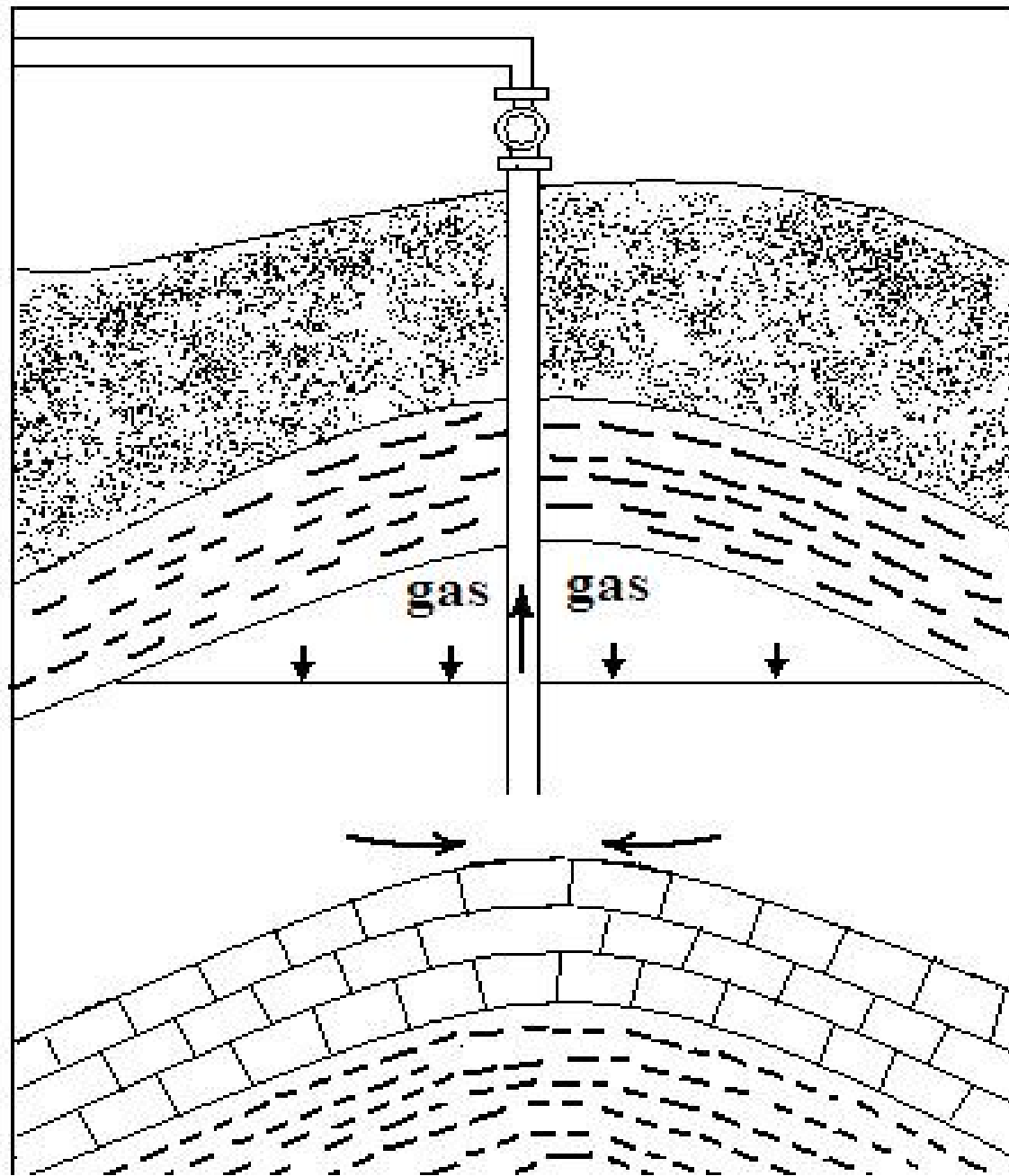

In Water drive is the most efficient method of natural drive where the propulsive force comes from the water accumulated under the oil.

Water forces the lighter recoverable oil out of the reservoir into the well.

In water drive, rate of removal should be adjusted properly so that water moves up evenly through the hole.

The recovery in a properly operated water drive may be as high as 80%.

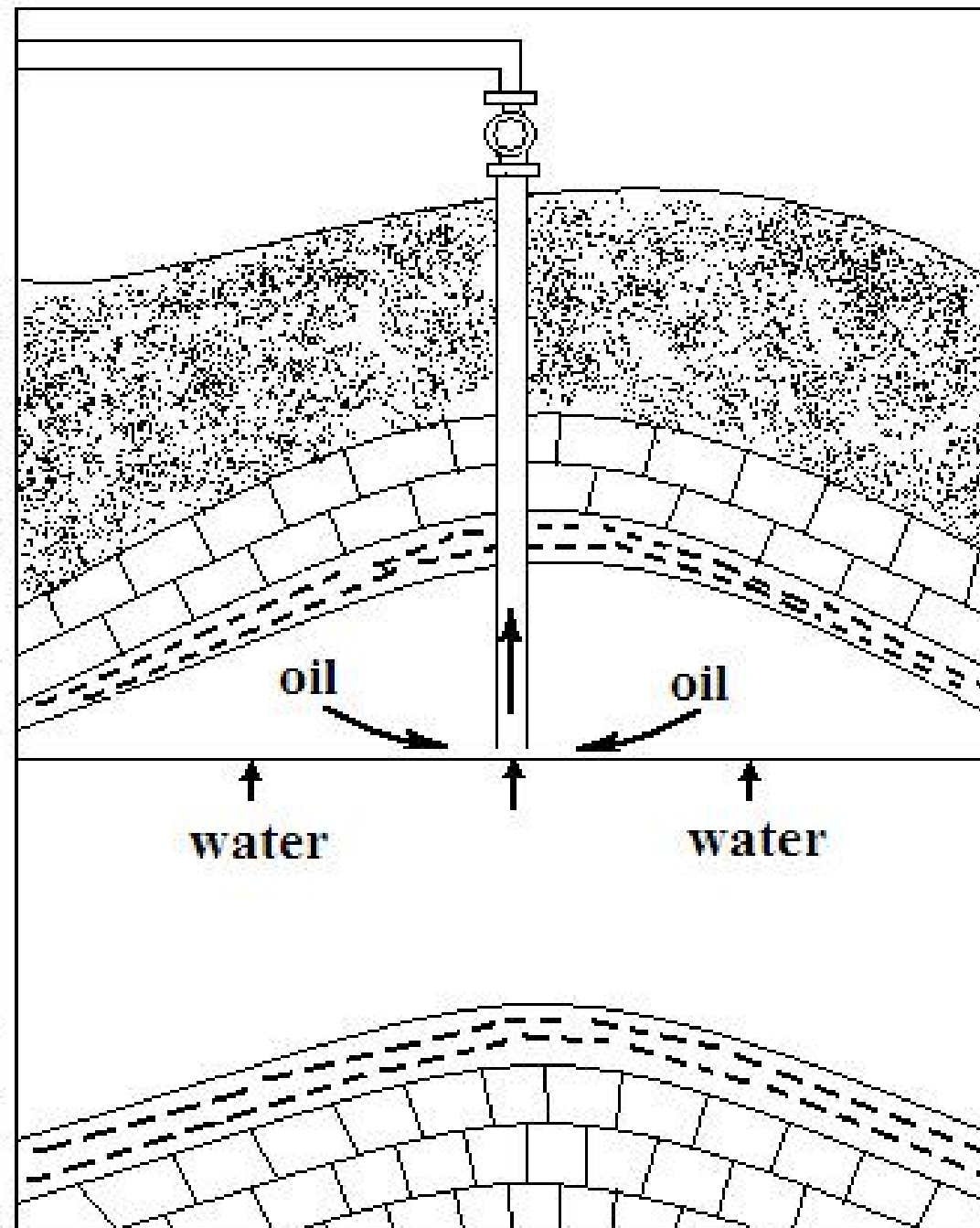

Improved oil recovery (IOR)

IOR is any activity which increases the recovery above that of the primary recovery.

It may include drilling extra wells or drilling horizontal wells, which intersect the reservoir areas which may otherwise be missed.

IOR may also be done by supplying energy to the reservoir.

IOR can be done by the two broad ways, **secondary recovery and enhanced oil recovery**.

Secondary recovery involves adding external energy without making any fundamental changes to the physical properties of the fluids.

This energy is added either by water or gas injection.

The secondary gas or water injection mimic the naturally occurring processes of solution gas drive and water drive respectively.

Enhanced oil recovery which is sometimes known as tertiary recovery involves adding external energy and creating fundamental changes to the physicochemical properties of the system.

The addition of external energy is in the form of using chemicals or heat to the reservoir to effect changes in fluid density, viscosity, interfacial forces or to change the wettability which affects the distribution of the oil, gas and water within the pores.

Evaluation of crude

Crude oils are roughly classified into different bases according to the nature of principal type of hydrocarbons present in it.

The bases are **paraffin base, naphthene based, mixed base or intermediate base and aromatic base.**

- ❖ Paraffin based crude oils composed of **mainly paraffins.**
- ❖ Mixed base or intermediate base crudes **are lower in n-paraffins and higher in naphthenes.**
- ❖ Naphthene base crudes are characterized by a **high percentage of naphthenes** and almost no presence of any wax.
- ❖ Aromatic base crudes contain a relatively **high percentage of the lower aromatic hydrocarbons.**

Important definitions.

API or API gravity is an empirical correlation which is actually a representation of **specific gravity of petroleum crude** or cuts (fractions).

Viscosity index is a property of petroleum fractions, which is defined as the **rate of change of viscosity with temperature**.

This is indicated by a number in an arbitrary scale ranging from 0 to 100, higher the number more is the viscosity index.

A viscosity index of 100 means, **oil which does not become viscous/ thin at lower/ higher temperature**.

Vaporisation characteristics of petroleum cuts are obtained by distilling a definite volume of the fraction in a specified apparatus.

As petroleum cuts are the mixture of different hydrocarbons, they do not have a definite boiling point, but have a boiling range.

Initial boiling point (IBP) of a petroleum cut is the temperature when first drop of distillate comes out of the condenser of the distillation apparatus.

Final boiling point (FBP) is the maximum temperature recorded at the end of the distillation. Distillation cannot be carried on beyond 350⁰C temperature at atmospheric pressure, because at this temperature, cracking of the hydrocarbons starts.

Flash point is defined as the minimum temperature at which the fuel upon heating evolves vapour which after mixing with the air give a sudden flash when a source of fire is brought in contact with it.

Fire point is the minimum temperature at which the fuel vapour in admixture with air will produce a continuous fire when a fire source is brought in contact with the vapour. So, the fire point is more than the flash point for a particular petroleum fraction.

During the transportation of heavy oil fractions in pipelines, there is a possibility of freezing the oil within the pipe when it is transported at cold climate.

Pour point is the maximum temperature, at which oil ceases to flow when it is cooled at specified condition. Pour point is reported by adding 2.8°C or 50F to this temperature, which is a caution to technical people.

Cloud point is the temperature at which oil becomes cloudy, when it is cooled at a specified condition.

Burning quality of kerosene can be determined by its burning capacity and it is expressed by two properties, **smoke point and char value**.

Smoke point is defined as the maximum flame height in millimeters when kerosene burns in a standard apparatus without producing any smoke or shoot.

Char value is the amount of char produced in milligrams on the wick of a standard apparatus per kilogram of kerosene burned.

Carbon residue is the important characteristic of the oils which are used in engines, burners and furnaces.

The carbonaceous residue obtained after heating the oil at a specified rate due to cracking and decomposition is called carbon residue.

Octane number determines the quality of gasoline or petrol.

When gasoline is burned in a spark ignition engine (petrol engine), it produces power.

A good quality gasoline burns smoothly without making any noise in the engine.

Whereas, burning of a bad quality gasoline is not smooth and produces a sudden high pressure by burning all fuel at a time, which forms pressure wave or detonation or knock to the engine.

The octane number of a gasoline is a measure of knocking tendency.

Octane number is determined by comparing the performance of a model fuel and the gasoline under test in a standard engine in laboratory.

The model fuel is prepared by mixing iso-octane (2,2,4 trimethyl pentane) whose octane number is assumed to be 100 and nheptane, whose octane number is assumed to be zero.

So, octane number of a gasoline sample is **defined as the percent by** volume of iso-octane in a model fuel (mixture of iso-octane and nheptane) whose knocking performance matches with the test gasoline.

Hence, a gasoline with octane number 90 means, its knocking tendency matches with a model fuel having 90 vol% isooctane.

The descending order of octane number of the hydrocarbons is:

aromatics>

isoparaffins>

naphthene>

olefins>

n-paraffins.

Ignition quality of diesel is expressed by **cetane number**

Diesel is injected in the hot compressed air in the cylinder of a diesel engine, which then burns to produce power.

If there is a large time gap between the injection and ignition, there is an unwanted accumulation of fuel in the cylinder, which suddenly burns at a time with a pressure wave, producing diesel knock.

Like octane number, here also a model fuel is prepared by mixing n-hexadecane or cetane (whose cetane number is assigned to 100) and α -methyl naphthalene (whose cetane number is assumed to be zero), at different volume proportions.

The percent by volume of n-hexadecane in a model fuel is the cetane number of the test diesel whose diesel knocking performance matches with the model fuel when tested in a specified engine.

Hence, if the performance of test diesel matches with the performance of the model fuel having 45/55 blend of cetane and ∞ -methyl naphthalene, then the diesel is assigned to cetane number of 45.

The descending order of cetane number of hydrocarbons is just reverse to that of octane number.

The assessment of a crude oil mainly involves the chemical evaluation of crude oil feedstocks by petroleum testing laboratories.

Each crude oil type has unique characteristics and no crude oil is identical to the other.

The results of crude oil assay testing provide extensive and detailed analytical data for a particular crude oil which are necessary for refinery.

For application of these methods, information about **distillation characteristics, density, sulfur content, viscosity** etc. of petroleum fractions are required.

Distillation

Crude oil is converted to salable products by combination of physical and chemical processes, collectively known as **refining of petroleum**.

Petroleum refining starts with crude oil distillation which is a physical separation process, followed by some chemical treatment steps, such as **cracking, reforming, hydrotreating etc** to produce a wide range of petroleum products of specific standard.

Crude oil distillation is done at atmospheric pressure as well as under vacuum.

A crude oil desalter is considered to be one of the facilities of atmospheric distillation unit.

Crude oil is first processed by desalter to remove salts, solids and water before introduction to the atmospheric distillation unit.

Desalted crude is then fractionated into intermediate petroleum products or cuts, such as, light naphtha, heavy naphtha, kerosene, gasoil and atmospheric residue (AR).

Atmospheric distillation produces cuts which boils upto 350⁰C.

The whole or part of (Atmospheric Residue) AR is treated in vacuum distillation unit to produce either vacuum gas oil (VGO) or lubricating oil depending on the type of the crude oil and vacuum residue (VR).

The vacuum distillation unit used for production of VGO is called a **fuel-type unit** and

the unit used for producing lubricating oil is said to be a **lube-type unit**.

Fractional distillation on lab scale

A specific amount of liquid fuel is taken in a standard round bottom flask with the arrangement of condenser and thermometer device.

The standard set-up , consisting of a flask, condenser, collector and thermometer. The fuel is heated

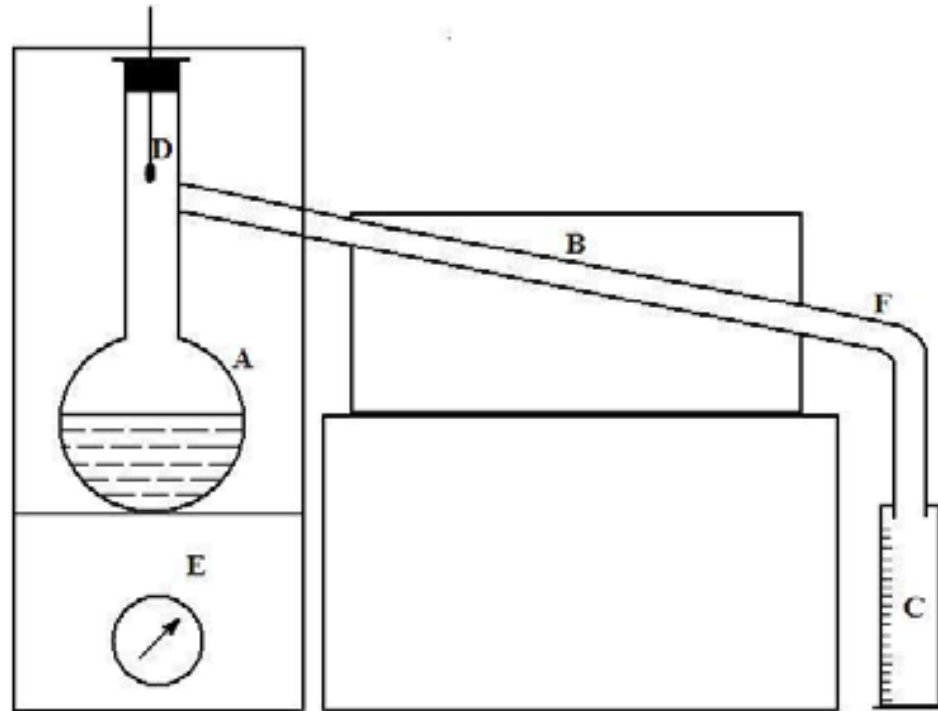

A= Flask,
B= Condenser,
C= Collector,
D= Thermometer,
E= Controller switch



CRUDE OIL DISTILLATION PROCESS

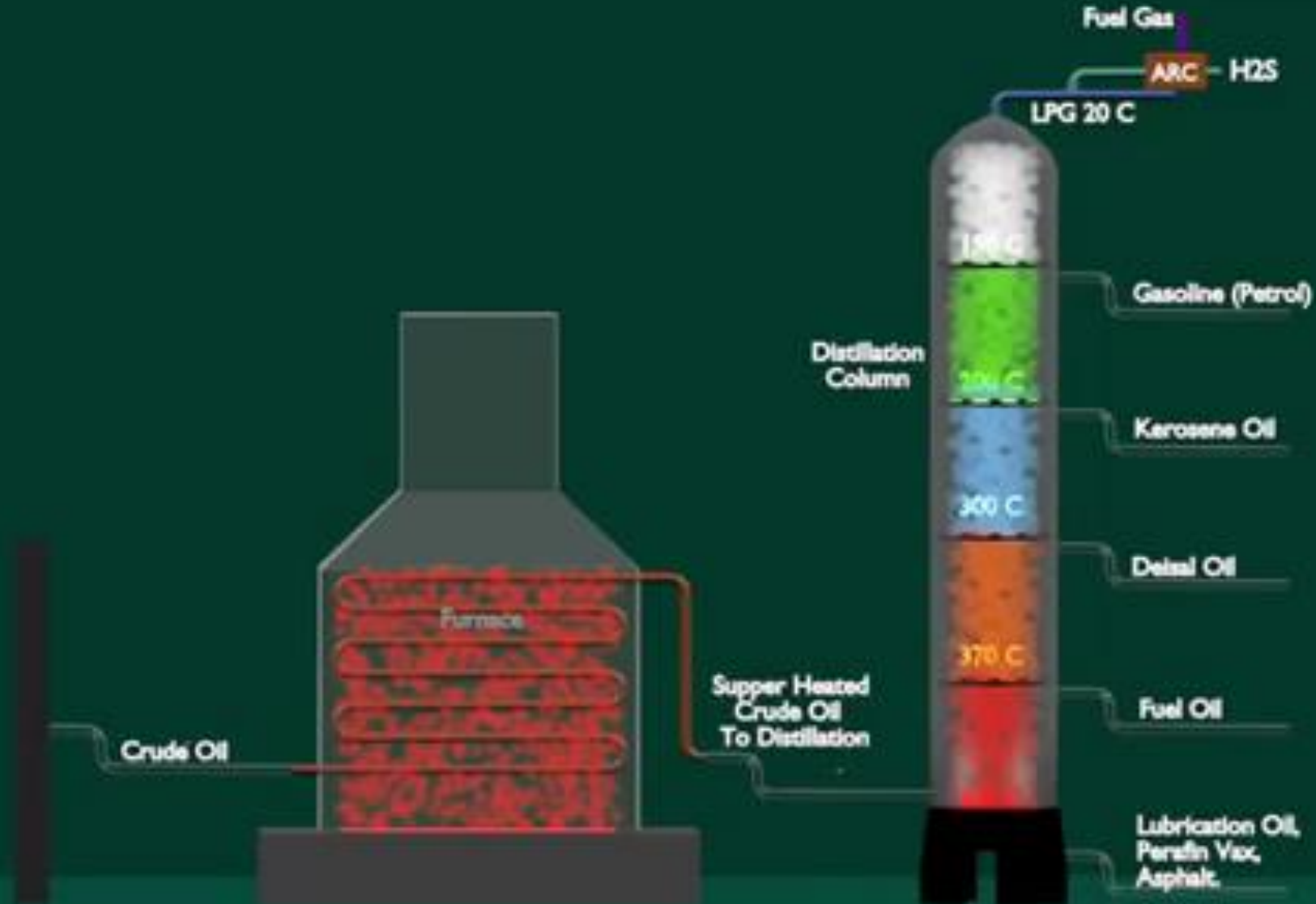

Atmospheric distillation

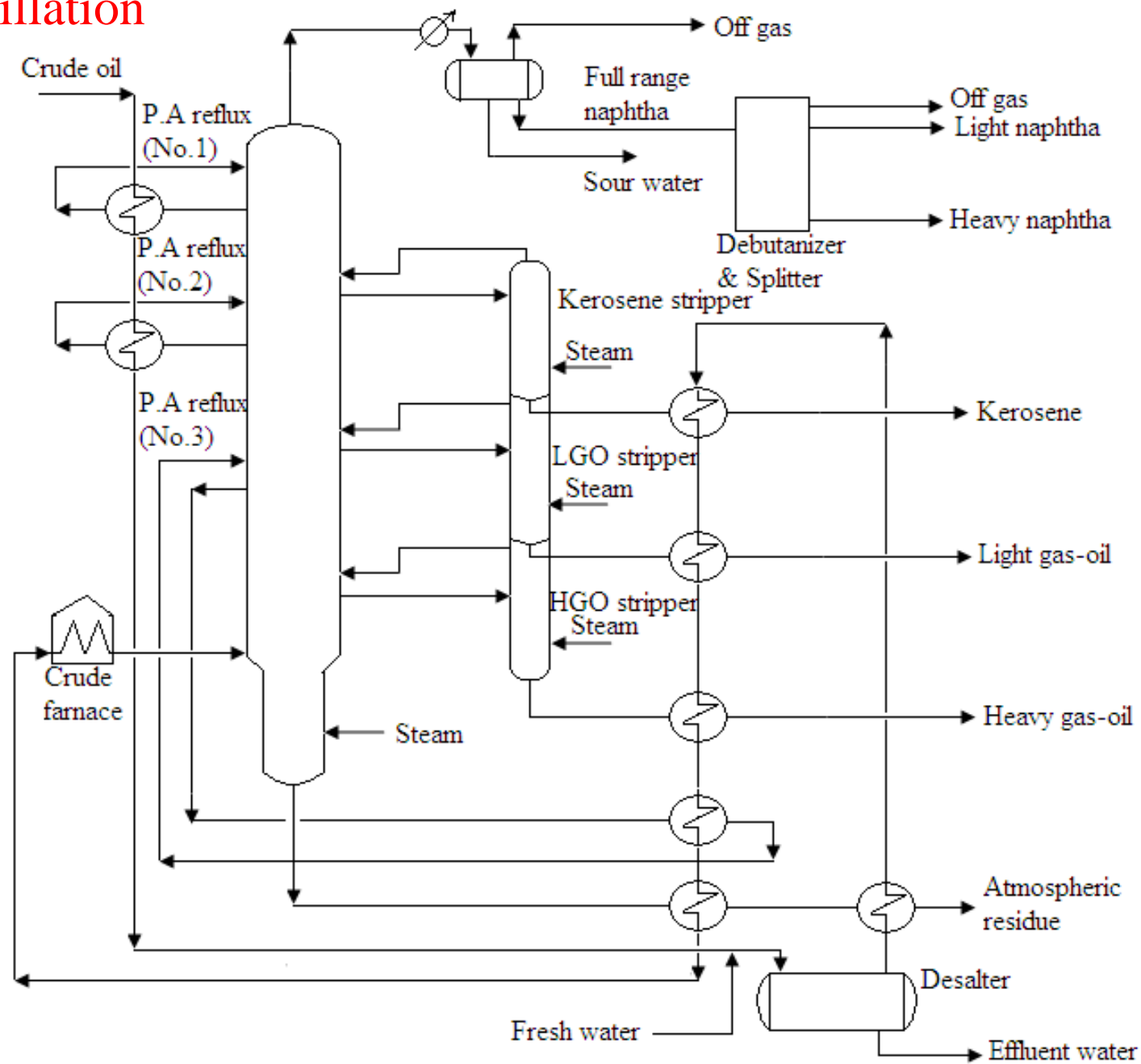

The atmospheric distillation unit consists of a **desalter, an atmospheric tower, three side strippers and a debutanizer/splitter.**

Crude oil is preheated and then sent to desalter.

Crude oil contains contaminants such as, salts, solids and water that may cause corrosion, fouling, plugging and catalyst degradation in the refinery units.

The salts contained in crude are mainly NaCl, CaCl₂, MgCl₂ and they are soluble in the water associated with crude oil.

This solution forms water-in-oil emulsion which is broken by applying high voltage electrostatic force.

In the desalter, the salt containing water forms large drops, which coalesces and then settles by gravity.

The desalted crude oil is then removed from the top of the vessel while effluent water is removed from the bottom.

Before being introduced into the atmospheric tower, crude oil is heated in a crude furnace, named pipe-still heater.

Most crude oil starts cracking or decomposition in the temperature range 340-370⁰C.

The typical furnace coil outlet temperature is maintained in the range 310-370⁰C depending on the nature of the crude oil.

From the desalter, the crude oil is preheated by exchanging heat with products and heated to a desired temperature of around 325⁰C.

At this temperature, the required degree of vaporization of crude occurs and then it is introduced into the flash zone of atmospheric tower.

The liquid portion of the crude flows down to the bottom stripping section of the tower where the distillate portion are vaporized with steam stripping.

Steam is injected at the bottom of the tower which strips out the distillate fractions from the crude and ascends through the column along with the flashed vapour.

This mixed vapour steam comes in contact with the down-flowing liquid on the trays where mass transfer of the components occur by condensation and vaporization and this way fractionation takes place.

Pump-around refluxes at different point of the tower at different temperatures are utilized for effective fractionation.

The condensed liquids are withdrawn at different side-trays as distillate products, such as, kerosene, light gas-oil and heavy gas-oil and the bottom product is recovered as atmospheric residue.

The overhead vapour of the tower is condensed by overhead condenser(s).

This condensed liquid is called full boiling range naphtha which is sent to a debutanizer to remove butane and lighter gas.

The gases which are not condensed in condenser and the debutanizer are taken out and sent to a gas separation unit to collect gases like, methane, ethane, ethylene, propane, propylene, butane and butylenes.

These gases have definite use, such as, propane and butane constitute Liquefied Petroleum Gas (LPG), methane, ethane are used as fuel and preparation of valuable chemicals, ethylene is the feedstock for first generation petrochemicals.

The full range naphtha withdrawn from overhead of the tower is stabilized in debutanizer (stabilization means removal of light gas components from naphtha to maintain a definite vapour pressure of it) and then sent to a splitter.

In splitter, naphtha is separated into light naphtha and heavy naphtha.

As an alternative to use splitter, light naphtha and heavy naphtha can be withdrawn as an overhead product and a side cut respectively from top of the atmospheric tower.

Kerosene, gas oils and atmospheric residue (AR) are obtained as the side cut from the tower.

There are generally two types of reflux systems used in the atmospheric distillation.

One is a pump-around reflux system and another is overhead reflux system.

In the case of pump around reflux system, some of the ascending vapour is condensed at the top part of the tower by exchanging heat with pump around reflux liquid and the condensed liquid flows down the column as internal reflux.

A Brief Introduction to Refluxing

In the overhead reflux system, the overhead vapours are condensed and this condensed liquid is sent back to the top section of the column as reflux.

Overhead reflux system may be again divided into two kinds, **cold reflux and hot reflux**.

In cold reflux system, vapour from the overhead of the tower is condensed by a condenser and then enters to an overhead reflux drum, where oil, water and gases are separated.

A part of the condensed oil is sent back to the top of the column as reflux and the remaining part is collected as naphtha product.

For hot reflux system, two sets of overhead condenser and reflux drums are used in series.

In the first condenser, heavier fraction of the overhead vapours are condensed and sent to the first reflux drum.

The lighter part goes to the second condenser, condensed and collected in the second drum.

The condensed liquid which is accumulated in the first drum is sent back to the top of the tower as reflux.

As the temperature of this reflux liquid is more than that of the cold reflux liquid, hence, the system is called hot reflux.

Cold reflux is comparatively simple in operation, but hot reflux reduces the corrosion in the tower top.

For both the cases, the diameter of the tower top is smaller than that for pump around reflux.

The main difference is of the pressure

Atmospheric has pressure of around 1–3 atm and the pressure for vacuum Distillation tower is below 1 atm.

So separation becomes easy in case of vacuum Distillation tower because of reduction in boiling point by lowering the pressure.

The bottom product from the atmospheric Distillation tower is taken into the vacuum Distillation Tower for further refining.

There is difference in the dimensions also the diameter of the vacuum Distillation tower is higher than the atmospheric Distillation tower.

While the height of vacuum Distillation tower is lower than that of the height of atmospheric Distillation tower.

The feed temperature for vacuum Distillation Tower is higher than the atmospheric Distillation tower.

Product range is limited for vacuum Distillation tower while it is not limited for atmospheric Distillation tower

Vacuum distillation

Atmospheric residue (AR) from atmospheric distillation tower contains several valuable cuts which should be recovered.

AR cannot be fractionated at atmospheric tower as fractionation of this cut needs excessive temperature where, cracking or decomposition of crude starts resulting in severe coke deposition.

Hence, AR is recovered as a bottom product from the tower and distilled under sub-atmospheric pressure.

AR is introduced into the vacuum distillation column after heat exchanging with distillation products, vacuum residue and pump-around reflux streams and finally heated in a furnace at required temperature.

Vacuum distillation furnace may be classified into two types, **wet and dry**.

In wet type, steam is injected into the furnace coils and that helps to lower the partial pressure of feed as well as steam carries the feed vapours through the furnace tube more rapidly.

In dry type, steam injection is not done in the furnace. Steam injection lowers the steam consumption in the vacuum ejector systems. The choice of the type depends on the overall economy of the refinery.

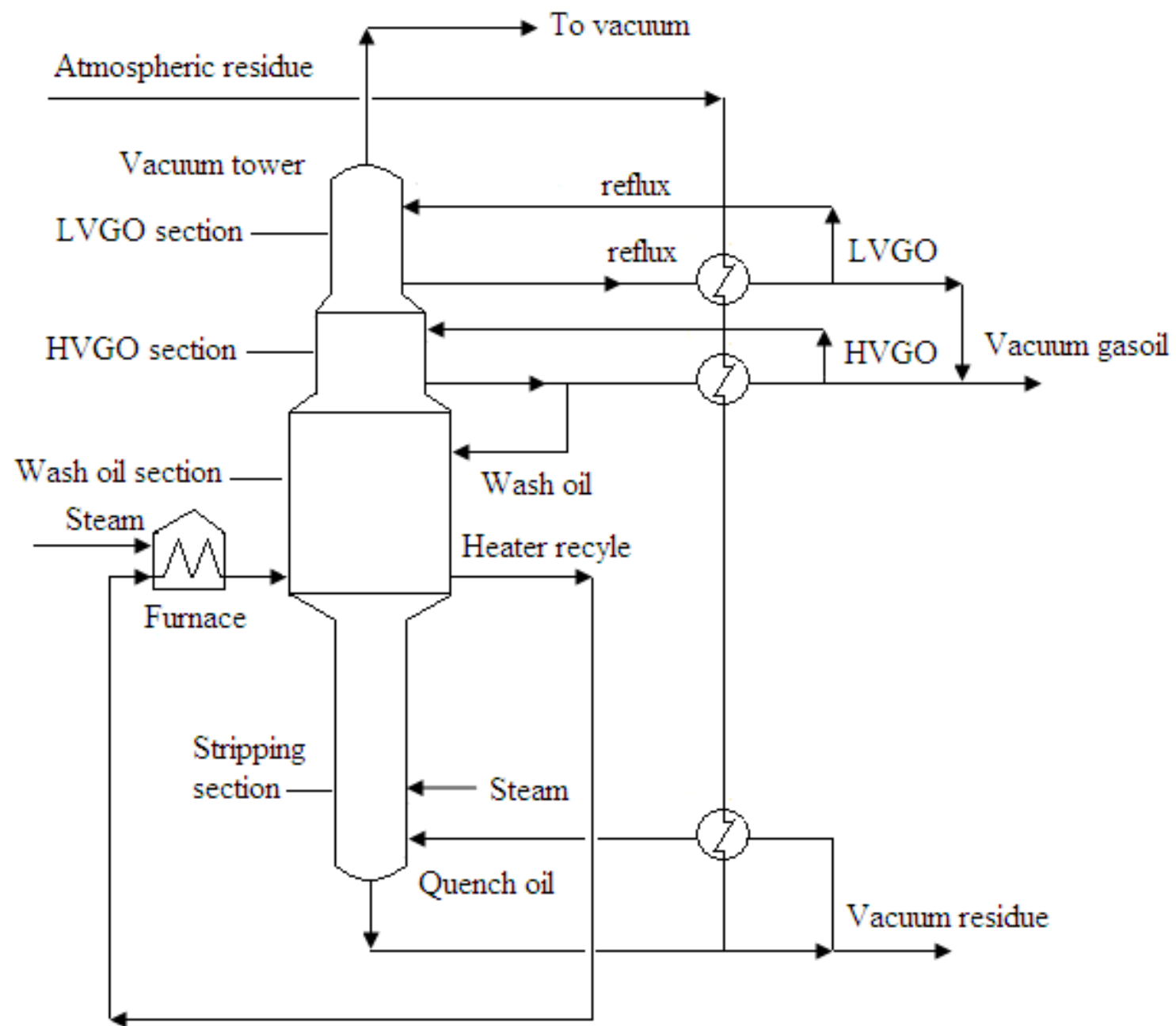

AR is flashed at the required temperature in the vacuum tower feed plate.

The liquid portion of the flashed feed flows downward in the stripping section and the vaporized part along with stripping steam goes up through the column.

Light vacuum gas oil (LVGO) and heavy vacuum gas oil (HVGO) is withdrawn from the side trays at their respective boiling ranges.

These two cuts may be collected together as per requirement.

Vacuum residue (VR) is withdrawn from the bottom of the tower, after the VGO portions are steam stripped.

VR should have required penetration index (This is a property of bitumen/VR, penetration of a bituminous material is the distance in tenths of mm, that a standard needle would penetrate vertically, into a sample of the material under standard conditions of temperature, load and time).

A small part of the cold VR is recycled at the bottom of the tower to prevent coking.

The vacuum tower can be divided into stripping section, wash oil section, HVGO section and LVGO section, from bottom to top, according to its product draw and working manner.

Stripping section is the bottom part of the distillation tower below feed plate, where stripping steam is introduced.

A mixture of the flashed vapour, stripped vapour from feed and steam flow up the column and enter into the wash oil section

At this section, this mixture comes in contact with internal reflux stream when any heavy oil fraction entrained in that vapour mixture is taken away by the reflux and lighter fraction from reflux comes in the up-flow stream.

This internal reflux is called wash oil.

The washed vapour stream goes up to the HVGO section and then to LVGO section.

HVGO and LVGO cuts are obtained from side draw trays by contacting with down-flow reflux liquid.

The internal reflux liquid is achieved by condensing the ascending vapour by cold pump-around reflux stream. HVGO and LVGO obtained after condensation from their respective trays and withdrawn as VGO product, either separately or together.

A part of the wash oil from wash oil section is withdrawn as side stream.

This oil containing some fraction of heavy oil is recycled to vacuum tower by mixing with the feed stream before heading to the furnace.

The overhead vapour of the vacuum tower, which is the mixture of steam and oil vapour, is precondensed to remove most of the steam and oil.

The uncondensed part is sent to the ejector system. Vacuum is created by using a series of ejectors and surface condensers.

The condensed overhead vapour and steam from pre-condenser and surface condensers are sent to an overhead drum, where gas, slop oil and sour water were separated.

In fuels-type vacuum distillation column, no side strippers are employed, as VGO is the only side product obtained, whose properties are mainly controlled by its metal content and carbon residue.

Gaseous fuels

Gaseous fuels are the most convenient fuel, which needs simplest and maintenance free burner systems due to absence of mineral as impurities. Gaseous fuels may be divided into four types:

(a) Fuels gases found in nature

1. Natural gas
2. Coal mine gas

(b) Gases produced from solid fuel

1. Producer gas
2. Water gas
3. Gases derived from coal (coal gas)
4. Gases derived from waste and Biomass(e.g. wood gas)
5. From other industrial processes (e.g. blast furnace gas)

(c) Gases produced from petroleum

1. Liquefied Petroleum gas (LPG)
2. Gases from oil gasification

(d) Gases obtained from some fermentation processes

Beside these, hydrogen and acetylene are two important gases those are widely used in the industries.

The combustion process is usually an oxidation reaction involving oxygen and the oxidant.

(1° Fuel) The most important gaseous fuels are natural gas.

(2° Fuel) Water gas, producer gas, coal gas and biogas.

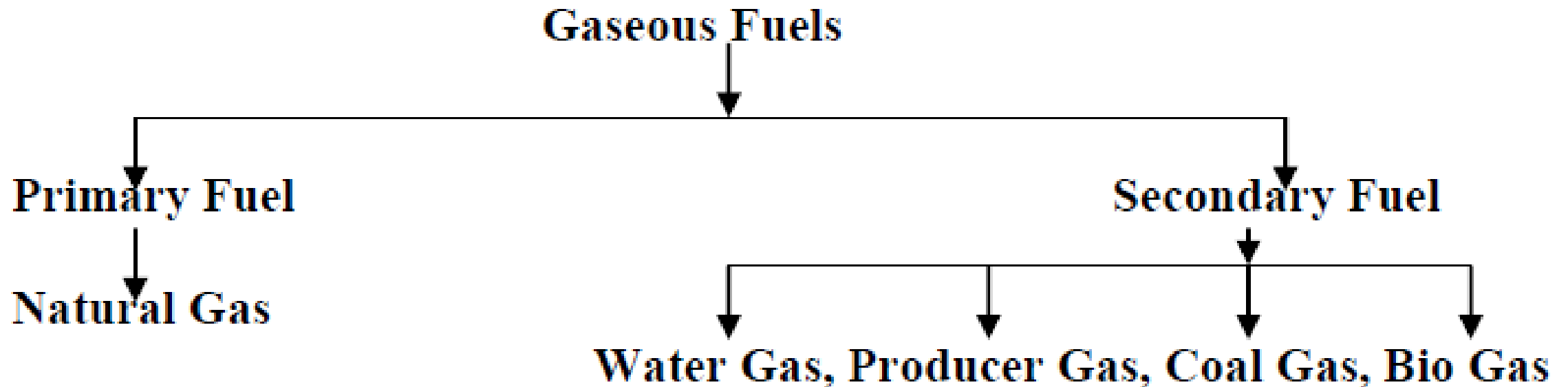

Gaseous fuels are obtained either naturally or by the treatment of solid or liquid fuel.

Among the naturally occurring gaseous fuels, natural gas and liquefied petroleum gas are most important.

These gases have high calorific value.

The classification of gaseous fuel does not solely depend on the calorific value of gas. Both the calorific value (CV) and specific gravity (Sp. gr.) of a gaseous fuel determine the thermal output of a heating appliance.

Flame speed of a gaseous fuel is also an important parameter to make a classification and it is represented by the tendency of the gas to react.

Flame speed is represented by a factor called Weaver flame speed factor, which is expressed on an arbitrary scale, where hydrogen is assumed to have 100 Weaver flame speed.

It is defined as the ratio of the laminar flame speed of the gas of interest with that of hydrogen.

The lower is the number the lower the flame speed.

Weaver speed factor is greatly influenced by the amount of hydrogen in the mixture.

Gaseous fuels have lower energy content than liquid fuels such as, petrol or diesel.

However, they are potentially more deserved fuel as they produce very low greenhouse gas upon burning and hence air quality benefits are obtained compared to conventional and petrol and diesel products.

a) Gases obtained naturally

Natural gas

Natural Gas is a naturally occurring mixture of hydrocarbon and non-hydrocarbon gases found in porous geological formations (reservoirs) beneath the earth's surface.

It may be obtained, often as an associated product of petroleum and also in gas reserve.

The chemical composition and heating value of natural gas varies with the reservoir source and the processing conditions.

Natural gas is primarily a mixture of methane with very little amount of C_2 to C_4 hydrocarbons.

In addition to fuel use, natural gas is a source of hydrogen for ammonia synthesis and a source of light hydrocarbons (i.e. ethane/propane/butane) for chemical synthesis or LG products.

In addition to fuel use, natural gas is a source of hydrogen for ammonia synthesis and a source of light hydrocarbons (i.e. ethane/propane/butane) for chemical synthesis or LG products.

Coal mine gas

The main constituent of coal mine gas is methane.

When coal beds are formed through the compression and heating of organic materials, methane is a gas formed as a part of the process of coal formation, known as coalification.

The methane content in coal seams generally increases with the deepness of seam, and also with age.

As the coal beds are mined, the entrapped or *adsorbed* methane is released from coal seams. This methane is a useful source of energy.

b) Fuel gases produced from solid fuel

Producer gas and water gas

Producer gas is obtained by blowing air or air-steam mixture on burning bed of solid fuel, such as coal.

It is a fuel of low calorific value with principal components carbon monoxide and nitrogen.

Hydrogen is also present in producer gas when air-steam mixture is used for blowing, which in turn, increases the calorific value.

Water gas is formed by the reaction of steam and solid fuel as coal or coke at high temperature.

This gaseous fuel is a mixture of carbon monoxide and hydrogen in equal proportion.

It's calorific value is about 2800 kCal/m³.

Coal gas, wood gas, blast furnace gas

Coal gas is a moderate calorific value gas, obtained by the process of high temperature carbonization of coal.

Its main use is as domestic fuel. It is a rich source of hydrogen.

Wood gas is obtained by gasification of wood logs, chips etc by air.

It is a mixture of CO_2 , CO , CH_4 , some olefins, H_2 and N_2 .

Its calorific value is around 1660 kCal/m³.

The combustion gases obtained from blast furnace during iron ore extraction by coke is the blast furnace gas.

It is a low calorific value fuel with main constituent being hydrogen and carbon dioxide.

c) Gases produced from petroleum Liquefied petroleum gas

Out of the gaseous hydrocarbons, the C_3 and C_4 compounds can be liquefied at room temperature by the application of moderate pressure.

This liquefied gas can be conveniently stored and transported in light pressure vessels and known as Liquefied Petroleum Gas or LPG.

The main source of C_3 and C_4 hydrocarbons is the fractionation of crude petroleum.

The atmospheric column of the crude distillation unit produces these hydrocarbon mixtures as a top product.

The combustion characteristics of LPG differ greatly from other gaseous fuels.

LPG has high calorific value, high specific gravity and high air requirement.

Gas from oil gasification

Liquid fuels are gasified to produce either gaseous fuel or synthesis gas.

The raw materials used for gasification are light distillates, middle distillates and heavy oils.

Gasification is done by air and steam, leading to the production of carbon monoxide and hydrogen along with smaller molecular weight hydrocarbons.

It is a high calorific value fuel because of the presence of hydrocarbons in it.

d) Gases from fermentation processes

Two important gaseous fuels, methane and hydrogen can be produced by the anaerobic fermentation of organic waste in presence of microbes.

The organic fractions of a waste are degraded by several groups of anaerobic bacteria to produce volatile fatty acids (VFAs) and hydrogen.

VFAs and hydrogen are further converted by methanogenic bacteria to methane.

Hydrogen and Acetylene

Hydrogen and acetylene both gases are produced from different chemical reactions in industries either as byproduct or as per requirement.

Hydrogen may be produced from electrolysis of water, partial oxidation of liquid fuel, dissociation of ammonia, synthesis gas production etc.

Acetylene is mainly prepared by the reaction of calcium carbide and water.

Coal Gas

Coal gas is a mixture of hydrogen, methane, carbon monoxide, acetylene, ethylene, nitrogen, carbon dioxide and some other gases. The composition of coal gas is following.

1. Hydrogen (H_2) ----- 40%
2. Methane (CH_4) ----- 32%
3. Carbon monoxide (CO) ----- 7%
4. Acetylene (C_2H_2) ----- 2%
5. Ethylene (C_2H_4) ----- 3%
6. Nitrogen (N_2) ----- 4%
7. Carbon dioxide (CO_2) ----- 1%
8. Rest ----- 4%

Coal gas is lighter than air and is colourless gas. It has a characteristic odour and burns with a smoky flame.

The calorific value is about 4900 Kcal/m³.

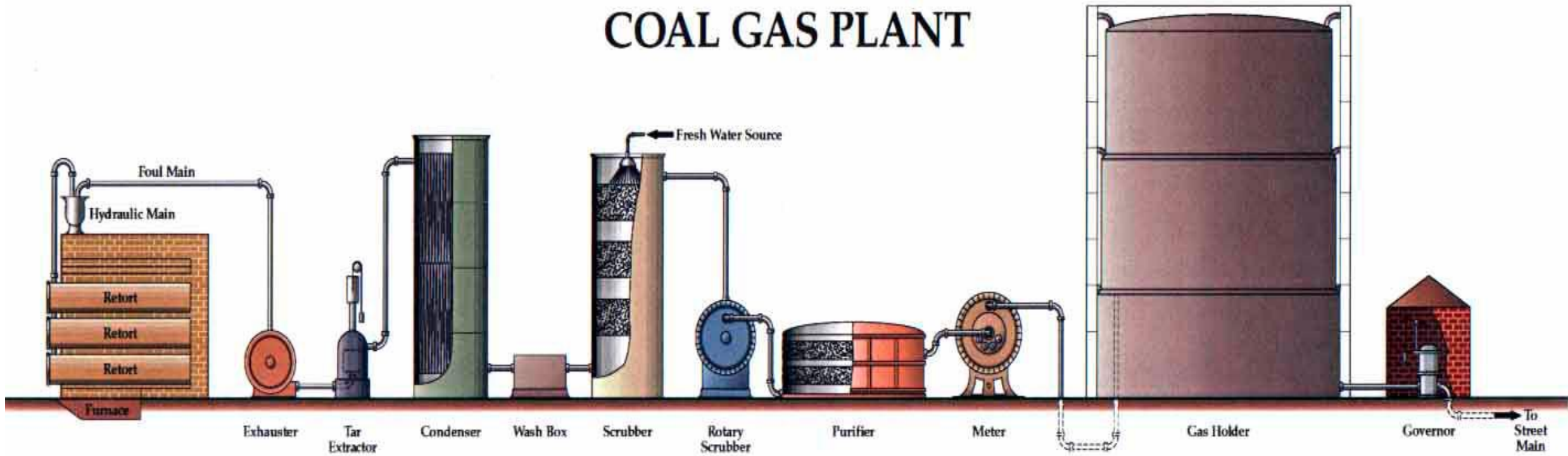

Production & Reactions

Coal gas is obtained, when coal is carbonized or heated in the absence of air at about 1,300 °C in either coke ovens or gas - making retorts.

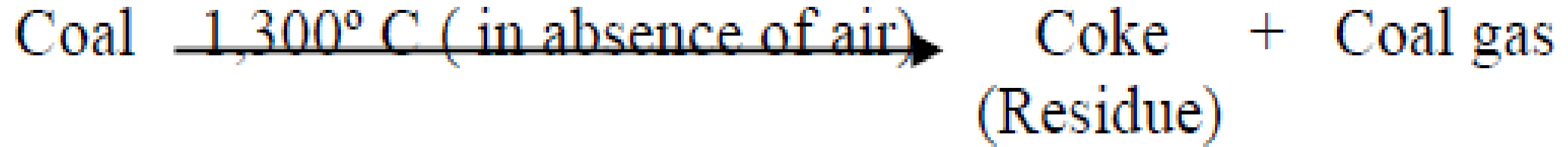

The gas coming out from the retort is impure.

It contains number of valuable impurities like-tar, ammonia, benzol, naphthalene and hydrogen sulphide.

The gas is first scrubbed by passing through a hydraulic main.

Much of the tar is then removed by cooling the gas in a huge water-cooled heat exchanger, called condenser.

The remaining tar and ammonia are removed by scrubbing with water in a scrubber.

The cooled gas is then scrubbed with creosote oil, which dissolves benzol, naphthalene etc.

The gas is then passed over moist ferric oxide, contained in a purifier to remove hydrogen sulphide.



When the iron oxide is exhausted, it is taken out from the purifier and exposed to air to oxidized to ferric oxide.



Applications

1. illuminant in cities and towns.
2. a fuel
3. in metallurgical operations for providing reducing atmosphere.

The purified coal gas is finally stored over water in gasholders.

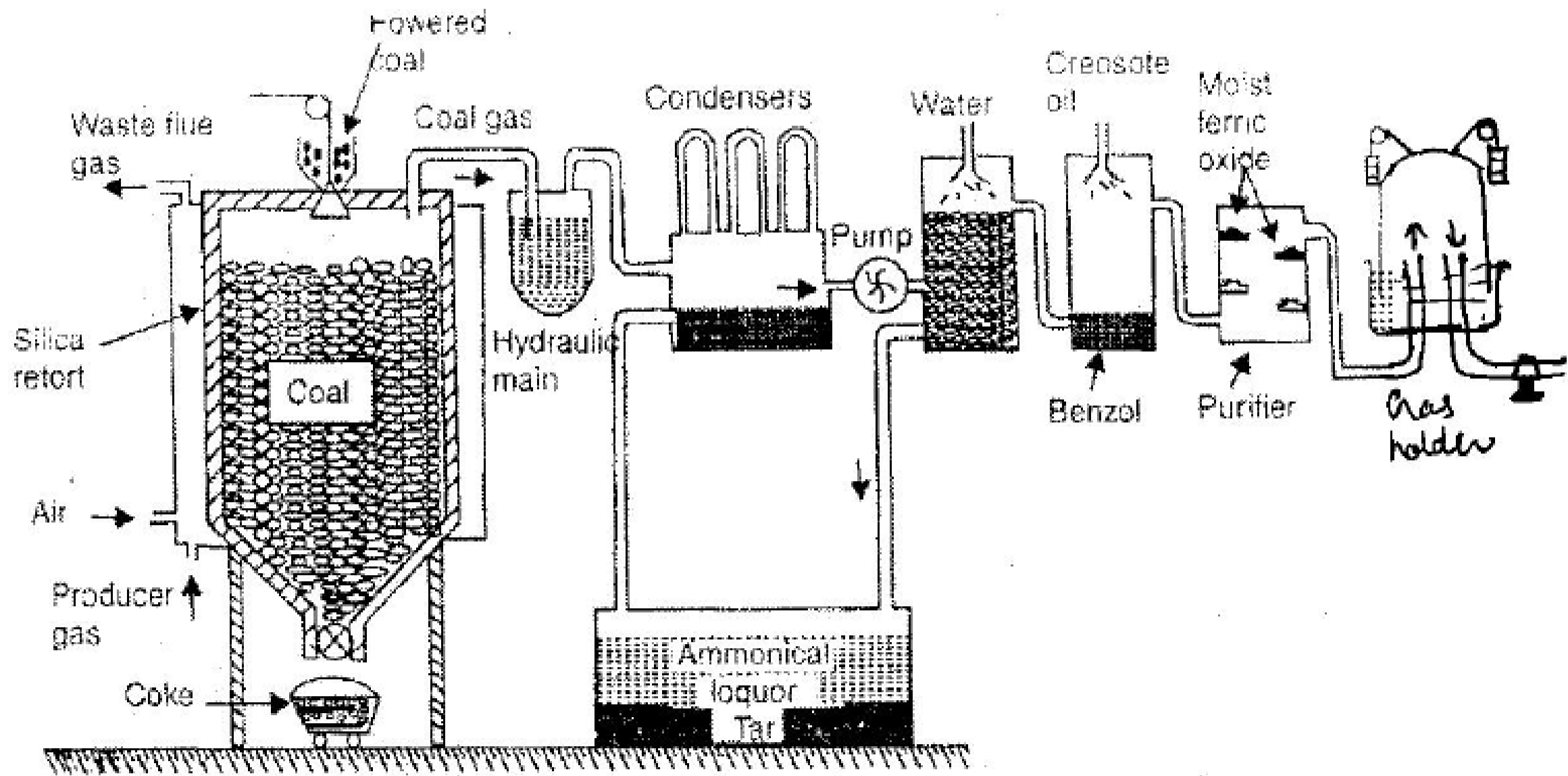

Acetylene

Acetylene is a combustible gas having a distinctive odour.

The gas becomes explosive when it is liquefied, compressed, heated, or mixed with air; hence special precautions are taken in handling this gas.

The common use of acetylene is in the preparation of various organic chemicals.

One of these chemicals is 1,4-butanediol, which is widely used in the preparation of polyurethane and polyester plastics.

Another important use of acetylene is in the oxy-acetylene welding and metal cutting.

Acetylene black is a product from acetylene which is used in dry-cell batteries.

One new application is the conversion of acetylene to ethylene for use in making a variety of polyethylene plastics.

Methods of preparation

Acetylene is manufactured by two processes; one is chemical process where calcium carbide reacts with water to produce acetylene gas and calcium carbonate slurry, called hydrated lime.

The chemical reaction may be written as



A considerable amount of heat is produced in this reaction, which must be removed to prevent explosion of acetylene gas at high temperature.

Heat removal is done by two processes, one is wet process and another one is dry process.

In wet process, either calcium carbide is added to water or water is added to calcium carbide.

This type is called wet process because an excess amount of water is used to absorb the heat of the reaction.

In dry process, a limited amount of water is used, which then evaporates as it absorbs the heat.

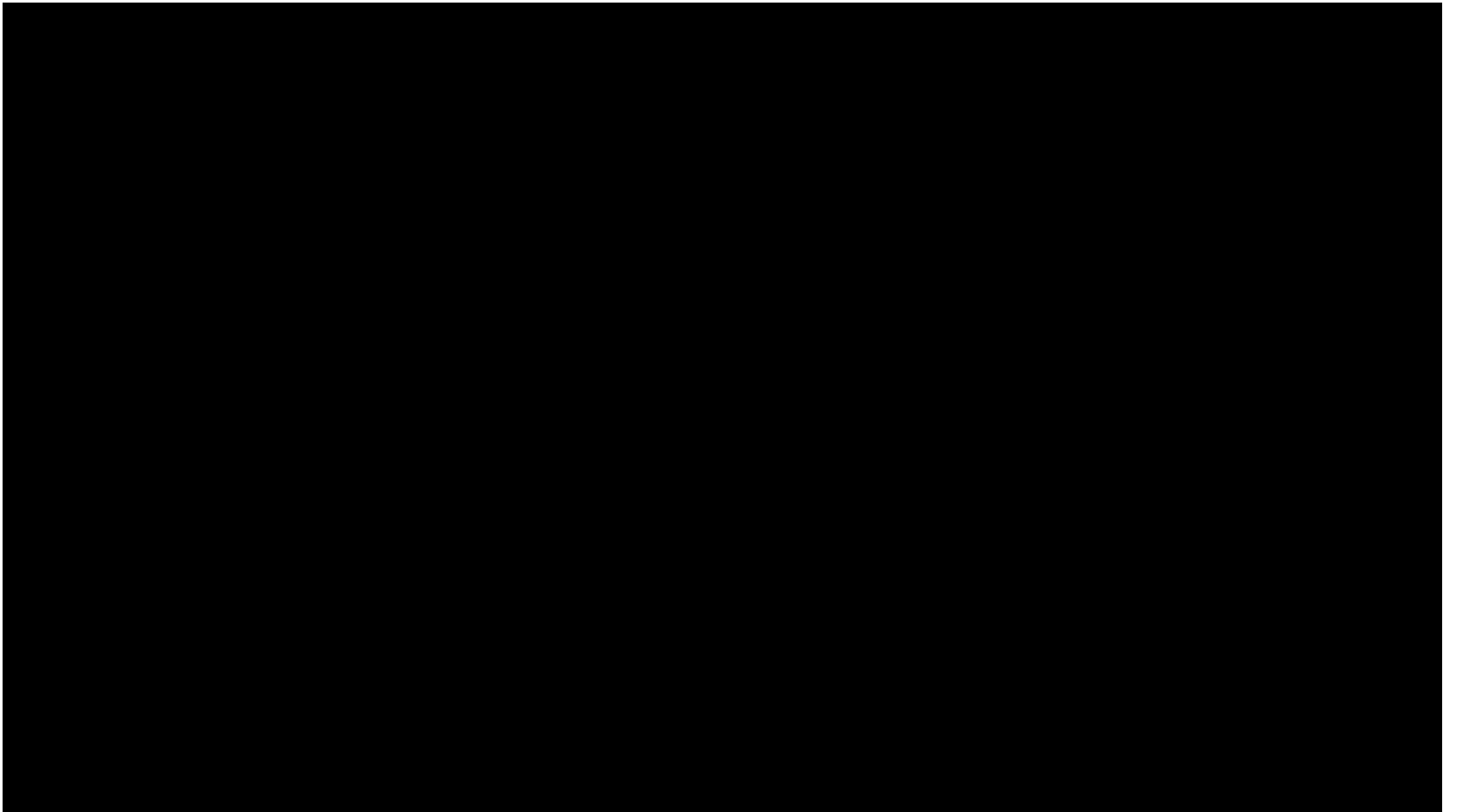

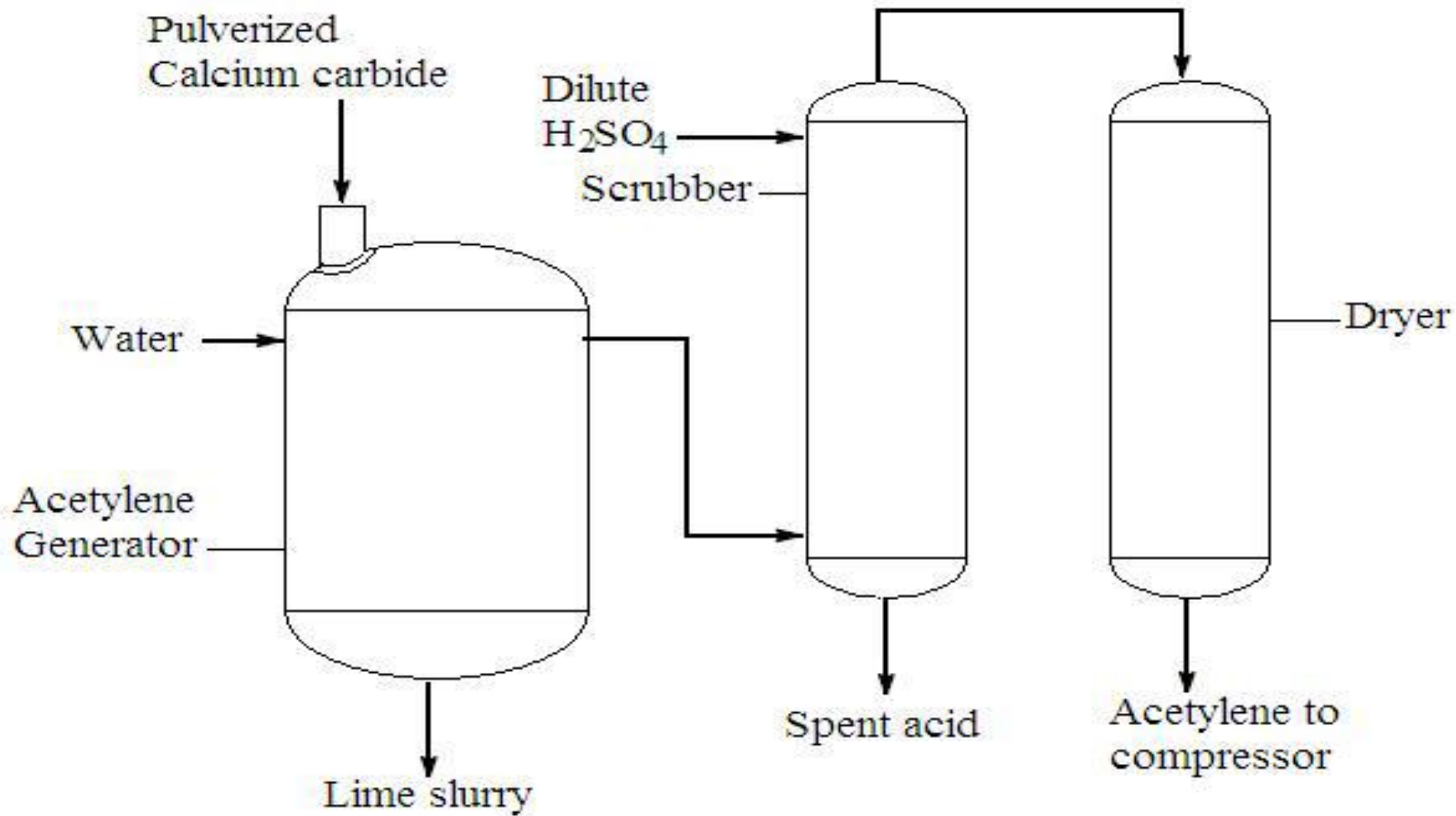

Figure shows a schematic view of acetylene generation unit.

The process starts with preparation of calcium carbide by the reaction of lime and coke in an electric arc furnace.

The carbon monoxide gas produced is removed and molten calcium carbide is recovered.

Calcium carbide is solidified and round under nitrogen atmosphere to avoid explosion of acetylene produced by the moist air coming in contact with the calcium carbide.

Pulverized CaC_2 is introduced in an acetylene gas generator through a hopper at the top of it and water is added.

In the wet process, sufficient quantity of water is added to remove calcium hydroxide formed in the reaction as lime slurry.

The temperature should be kept below 90°C and pressure is within 2 atm.

In the dry process, 1:1 quantity by weight of water to CaC_2 is used. This water is removed by the heat of reaction to produce acetylene.

The cooler condenser cools the acetylene gas from the generator, which is hot along with moisture and other gaseous impurities.

The impurities are traces of ammonia, sulfides and phosphene which are scrubbed by dilute H_2SO_4 solution.

The gas is then again purified and dried with iron oxide and alumina or silica gel.

Other processes for C₂H₂ generation

Other processes use different hydrocarbons such as crude oil and naphtha.

Even coal is also used as raw materials.

This is a thermal cracking process in which the raw materials are converted into hydrogen, carbon monoxide, carbon dioxide and acetylene.

There are several variations of this process which depends on the raw materials used and the method of heat generation.

Electric arc furnace is used for some cracking processes to heat the raw materials, while others use a combustion chamber where heat is provided by burning a part of the hydrocarbons.

Steam cracking of ethylene is another process to generate acetylene as a side product.

The process of producing acetylene from natural gas using combustion chamber is described below.

The chemical reaction for converting methane into acetylene and hydrogen may be written as



Natural gas, which is mostly methane, is preheated to about 650° C. for the purpose of its selfignition once it reaches the burner and this requires less oxygen for combustion.

This hot gas passes through a narrow tube, called venture and at this stage oxygen is mixed to the gas.

The gas mixture then passes through a diffuser, which makes a desired speed of the gas mixture.

This is very important and critical.

If the velocity is too high, the incoming gas will blow out the flame in the burner.

If the velocity is too low, the flame can flash back and ignite the gas before it reaches the burner.

After the diffuser, the gas mixture comes to the burner which comprises of more than 100 narrow channels.

The gas flows through these channel and self ignites to raise the temperature of the gas up to 1500⁰C.

Here some oxygen is also added. After the burner, reaction space comes, where the burning methane is converted to acetylene.

The whole process is very fast, the time required is only some milliseconds.

After the reaction, the burning gas is quickly quenched with water sprays.

The cooled gas contains a large amount of carbon monoxide, carbon dioxide, hydrogen and unreacted methane along with acetylene.

Some carbon soot is also formed. The gas passes through a water scrubber, which removes much of the carbon soot.

In the second scrubber, N-methylpyrrolidinone solvent is used to absorb acetylene from the gas mixtures.

The solvent is pumped into a separation tower where acetylene is boiled out of the solvent and is drawn off at the top of the tower as a gas, while the solvent is drawn out of the bottom.

Handling and safety

Because of its explosive nature, acetylene must be stored and handled with utmost care.

In the chemical plants where acetylene is needed, it is produced very near to its point of consumption and is transported through a very short pipeline at low pressure.

For use in oxy-acetylene welding purpose, acetylene must be stored in a special cylinder where an absorbent, like diatomaceous earth and a small amount of acetone is kept.

At the cylinder pressure, 300 psi, acetylene is dissolved in acetone and this dissolution makes acetylene to lose its explosive power.

When pressure is released by opening the cylinder valve, some acetylene vaporizes and comes out through the tube connected to the cylinder for welding or cutting torch.

Oerlikon 20mm AA gun (Acetylene Gas Mockup)

A [Oerlikon 20mm AA gun](#) is used in the final battle, wielded by Col. Trautman ([Richard Crenna](#)), however it is mysteriously missing a rear sight and (most importantly) the drum magazine - This is an auto cannon with no ammunition. The one used in the film was an 'acetylene' gun (a real weapon mocked up with Acetylene gas internals to 'fake firing'). This method is used many times in either helicopter mounted guns (for safety) and heavy machine guns. They fire a 'flash of fire' rather slowly to simulate the firing of a large machine gun round. Supplied by Ellis Mercantile for the film during the re-shoot of the final battle in the U.S.





Trautman mans a fake Oerlikon 20mm gun. (For an example of a correct live-firing Oerlikon gun, see the Stealth page.)



Colonel Trautman tracks the Fake Hind Gunship with his Oerlikon. In reality, one direct hit in a vital area from a 20mm shell at that range would down the helicopter immediately.



Good side shot of the "Acetylene Gas firing" Oerlikon.



Col. Trautman fires 'acetylene fire' from the front of his fake autocannon. This is a common special effect 'trick' used in movies when blanks are either too dangerous, too expensive, or too much of a hassle.



VIDEO



Natural Gas

a) Gases obtained naturally

Natural gas

Previous class

Natural Gas is a naturally occurring mixture of hydrocarbon and non-hydrocarbon gases found in porous geological formations (reservoirs) beneath the earth's surface.

It may be obtained, often as an associated product of petroleum and also in gas reserve.

The chemical composition and heating value of natural gas varies with the reservoir source and the processing conditions.

Natural gas is primarily a mixture of methane with very little amount of C_2 to C_4 hydrocarbons.

In addition to fuel use, natural gas is a source of hydrogen for ammonia synthesis and a source of light hydrocarbons (i.e. ethane/propane/butane) for chemical synthesis or LG products.

Natural gas is usually a mixture of methane, ethane, propane, butane, pentane and sometimes a small amount of C₅+ hydrocarbons.

The major constituent is methane.

Except these, hydrogen sulphide is sometimes obtained in natural gas, although it is not very common.

The natural gas containing high amount of hydrogen sulphide is termed as **sour gas** and that contains low amount of hydrogen sulphide is termed as **sweet gas**.

Common but trace constituent gases are carbon dioxide and nitrogen with average proportions in the range of 0.5 to 10% and 0.5 to 5% respectively.

Broadly natural gas is classified in three types :

- 1) Non-associated gas, which is not in contact with oil in the reservoir.
- 2) Gas-cap associated gas, which is overlying the oil phase in the reservoir.
- 3) Associated gas which is dissolved in the oil at the reservoir condition (solution gas).

Gas-oil ratio (GOR)

Gas-oil ratio (GOR) is the ratio of the volume of gas to the volume of oil at normal or standard conditions of temperature and pressure.

It determines the amount of gas dissolved in oil in a reservoir.

GOR 1 represents that, 1 m³ of gas is recovered at the separator per m³ of oil extracted at normal temperature and pressure.

This ratio varies from a few fractions of a cubic meter to more than 150 cm³ of associated gas per m³ of oil.

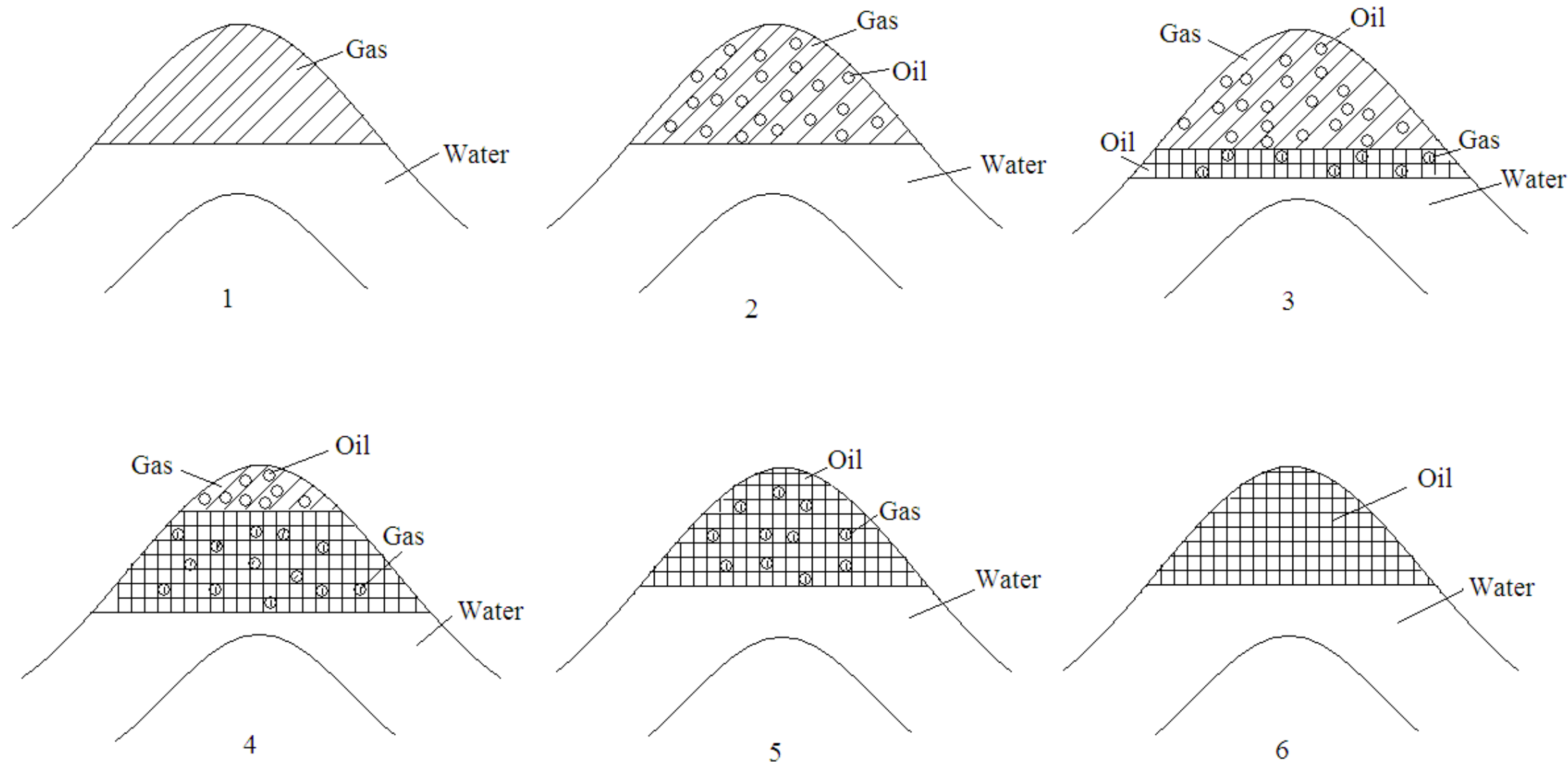

Gas-oil contact in different types of reserve

Example 1 represents a dry natural gas reserve, which may contain some carbon dioxide and nitrogen along with lower hydrocarbon gases mixed with the major component methane. Gas is located above the water phase accumulated at the bottom of the reservoir.

Example 2 shows a picture of condensate gas. The reservoir contains liquid hydrocarbons in large proportions which are dissolved in gas phase.

In example 3, the quantity of liquid hydrocarbons phase is quite high, so that, at the thermodynamic condition of the reservoir, the liquid and gaseous phases co-exist.

In this condition, the gas phase contains dissolved hydrocarbons of liquid range and liquid oil contains dissolved gases.

Although the liquid phase is of sufficient quantity, but the major phase is gas, hence, the former forms an 'oil-ring' between the gas phase and water.

The reservoir shown in example 4 has oil as its major component. This is primarily an oil reservoir containing a gas cap over it.

The gases are dissolved in the oil and some oil is also dissolved in gas.

Example 5 shows an oil reserve having gas dissolved in liquid oil. The amount of gas is quite small in amount.

Example 6 depicts an oil reserve with no gas dissolved in oil.

Non-associated gas can also be ‘wet gas’, which means that it contains appreciable amount of ethane, propane, butane and some higher hydrocarbons.

Except methane, other hydrocarbons are condensed to form ‘condensate’. This condensate can be mixed with naphtha fraction

Natural gas has calorific value in the range of 8400 to 9100 Kcal/Nm³.

Hence, this is a high calorific value gas.

CNG (compressed natural gas) and LNG (liquefied natural gas) are both the forms of natural gas or methane.

Whilst it is common to confuse the two varieties, the key difference is that CNG is stored as a gas at a high pressure, whereas LNG is cooled to -160⁰C which causes it to become liquid.

Both the fuels are used in light passenger vehicles.

What is the distinction between CNG, PNG & LNG

CNG is natural gas compressed to a pressure of 200 – 250 kg/cm² to enhance the vehicle on-board storage capacity. Thus this compressed form of natural gas is used as a fuel for transportation purposes.

PNG is Piped Natural Gas supplied homes and establishments. PNG installations contain only a limited quantity of natural gas a low pressure and is much safer compared to LPG which is stored in a cylinder.

LNG is liquefied Natural gas cooled to a temperature of below – 161°C. It does not contain any other impurities such as oil, particulates, H₂S or Oxygen.

Santos

GLNG Project

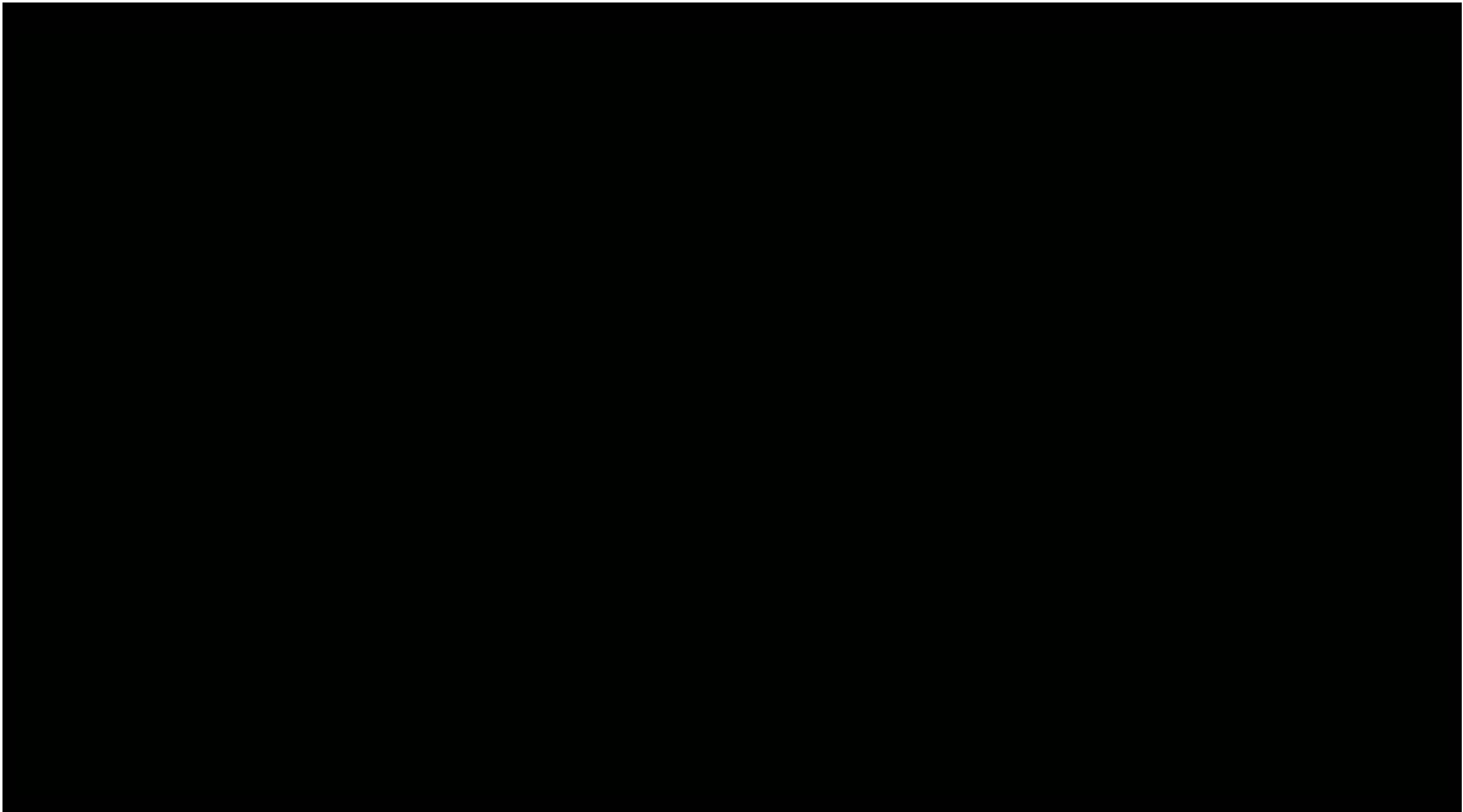

Liquefied Petroleum Gas

c) Gases produced from petroleum **Liquefied petroleum gas** **Previous class**

Out of the gaseous hydrocarbons, the C_3 and C_4 compounds can be liquefied at room temperature by the application of moderate pressure.

This liquefied gas can be conveniently stored and transported in light pressure vessels and known as Liquefied Petroleum Gas or LPG.

The main source of C_3 and C_4 hydrocarbons is the fractionation of crude petroleum.

The atmospheric column of the crude distillation unit produces these hydrocarbon mixtures as a top product.

The combustion characteristics of LPG differ greatly from other gaseous fuels.

LPG has high calorific value, high specific gravity and high air requirement.

Liquefied petroleum gas or LPG in short, is a colourless and volatile hydrocarbon gas which is obtained from refinery gas or natural gas (including associated gas in oilfields) through pressurizing, cooling and liquefaction.

The constituents of LPG from refinery gas are mainly propane, propylene, butane, butylene, with a small amount of pentane and pentylene, as well as a little amount of sulfide impurities.

LPG from natural gas scarcely contains olefins.

LPG has main use as industrial and domestic fuel as well as combustion engine fuel.

LPG is a flammable gas and explodes when its concentration in the air reaches a certain value.

LPG remains in gaseous state at atmospheric pressure and normal ambient temperatures, but it can be liquefied when moderate pressure is applied or when the temperature is sufficiently reduced, and this way it is stored in cylinders.

Compared with other fuels, LPG has the following particular advantages of less pollution, higher heat generation because of its very high calorific value, ease of transportation by roadways (tankers) and waterways (vessels).

Storage of LPG is also very convenient.

It can be stored in tanks and can be filled in cylinders for customer use. LPG can also be supplied through gas distribution station and pipelines.

Moreover, it is free of smoke, dust and carbon residue.

Due to the above advantages of LPG, it is widely used as industrial, commercial and domestic fuel.

In addition to these, LPG is a useful raw material for chemical industry.

Pyrolysis gas produced from the thermal cracking and catalytic cracking processes is a major source of LPG.

The major components of pyrolysis gas are hydrogen, methane, ethane, ethylene, propane, propylene, butane, butylene, and C5+.

These hydrocarbons may be separated by cold separation process and LPG may be prepared by liquefying C4 and C5 gases which can be stored in cylinders.

On opening the valve of the LPG cylinders, the flammable gaseous hydrocarbons pass through the pipes into the burner.

LPG forms blue flame on ignition, giving out a large amount of heat during the combustion (with heat generation value of 92,100 kJ/m³-121,400 kJ/m³).

The constituents of LPG can be separated and used to produce synthetic plastic, synthetic rubber, synthetic fibre, pharmaceuticals, explosives, dyestuff, etc.

Although LPG is a convenient fuel but it is dangerous too.

If the pipeline leaks or the valve is not tightly closed, LPG spreads into the room. When its content reaches the explosion limit, LPG will explode if it comes in contact with any sparks.

Because of this nature of this gas, LPG processing plants often mix a little amount of bad odourous mercaptan or thioether derivatives with LPG to detect its leakage.

When LPG leaks, it can be smelled instantly and corresponding emergency measures can be taken.

IOCL -
Hazira LPG
Bottling
Plant

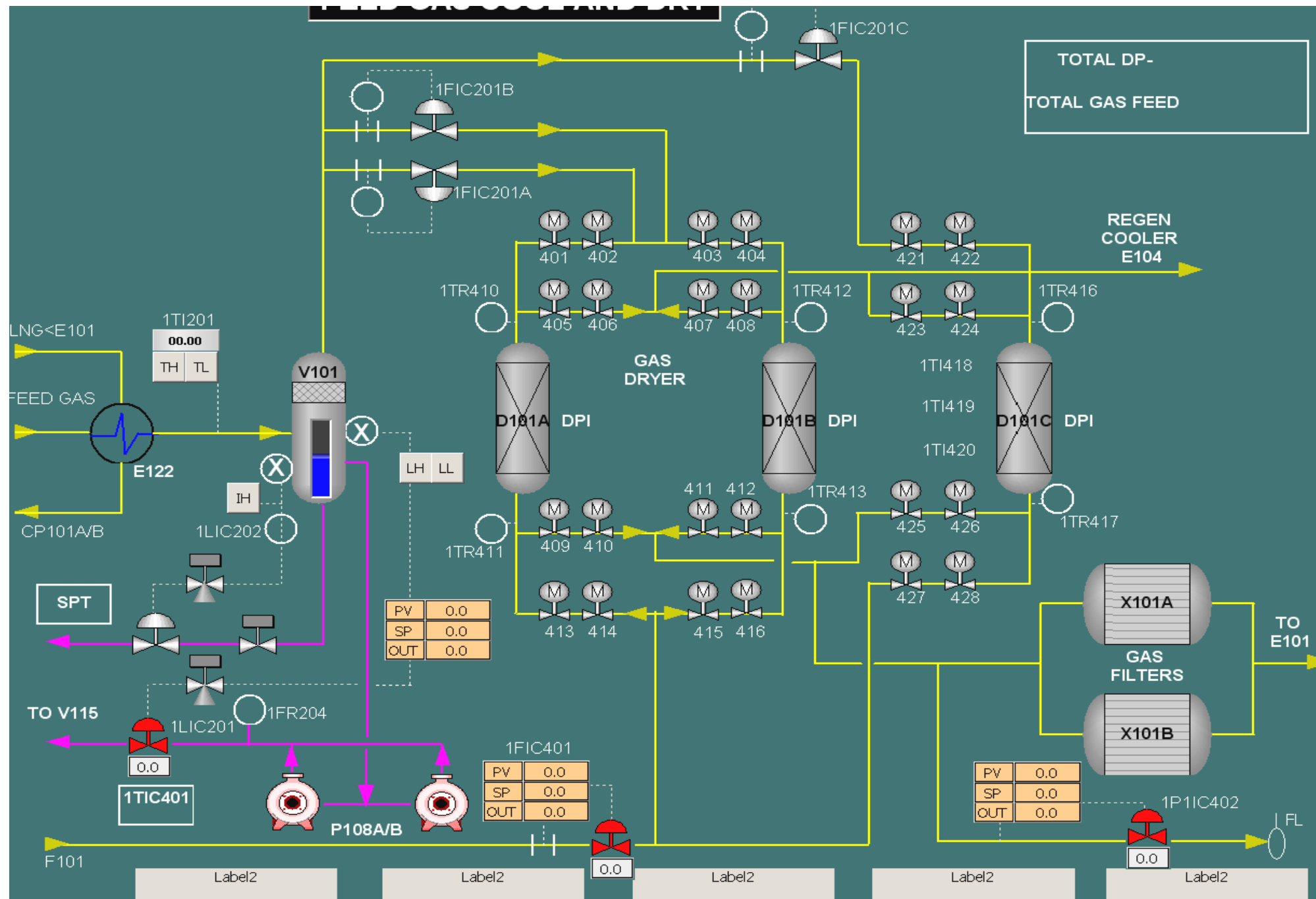

HP GAS SECTION

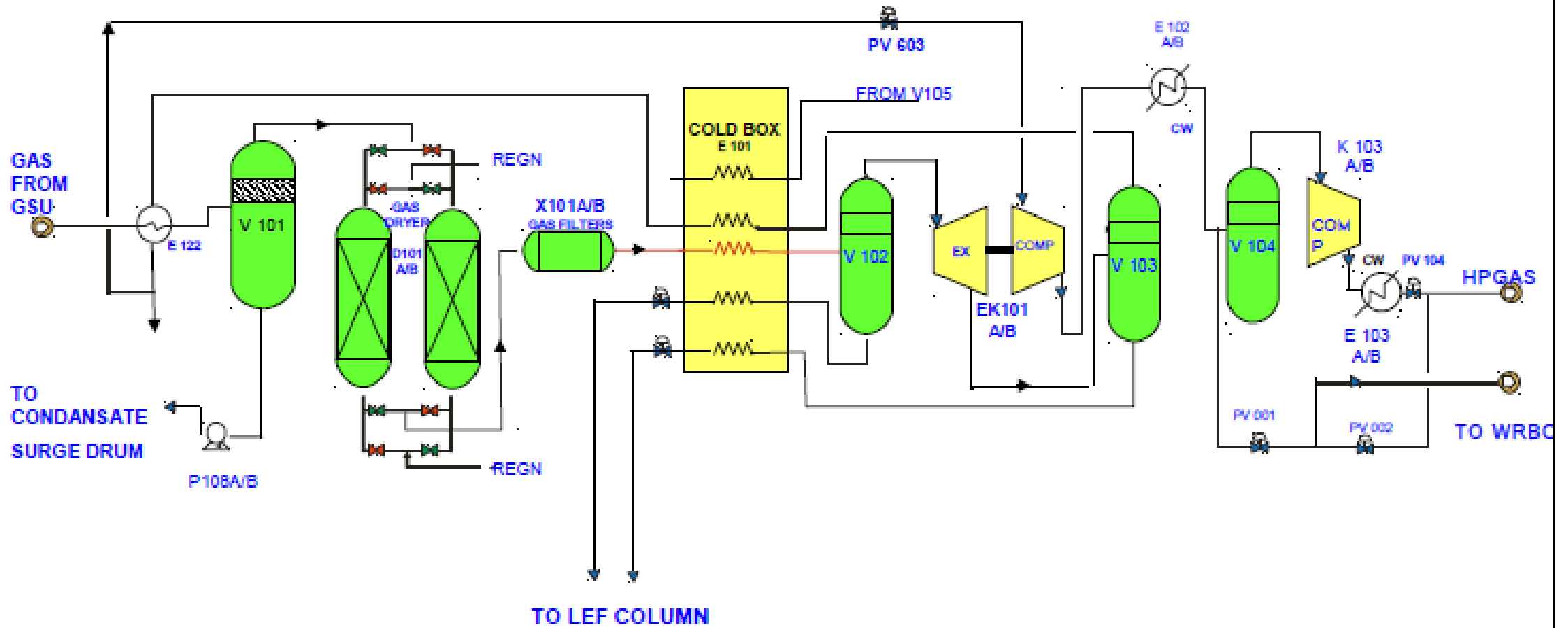

LIQUID SECTION

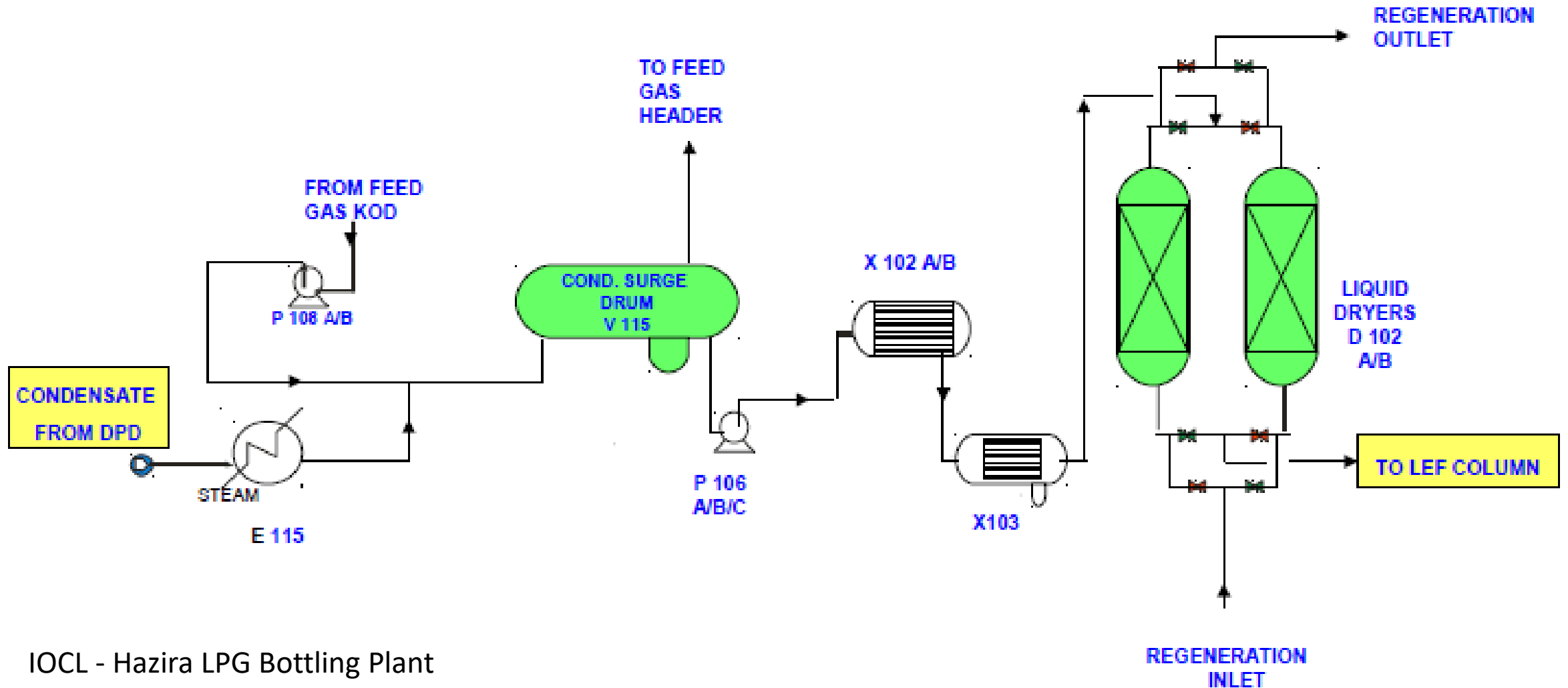

IOCL - Hazira LPG Bottling Plant

UNDERSTANDING COLUMN

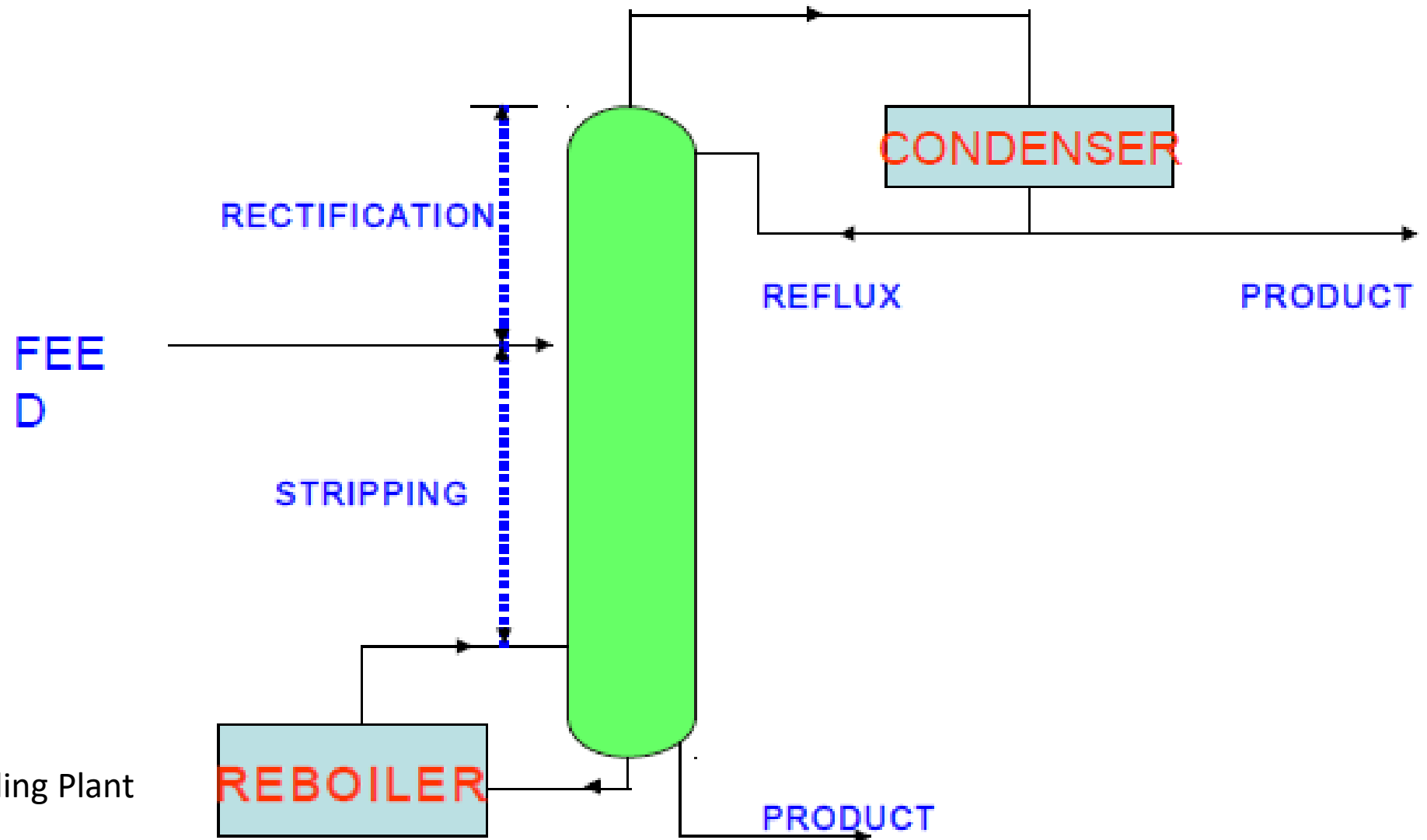

IOCL - Hazira LPG Bottling Plant

COLUMN SECTION

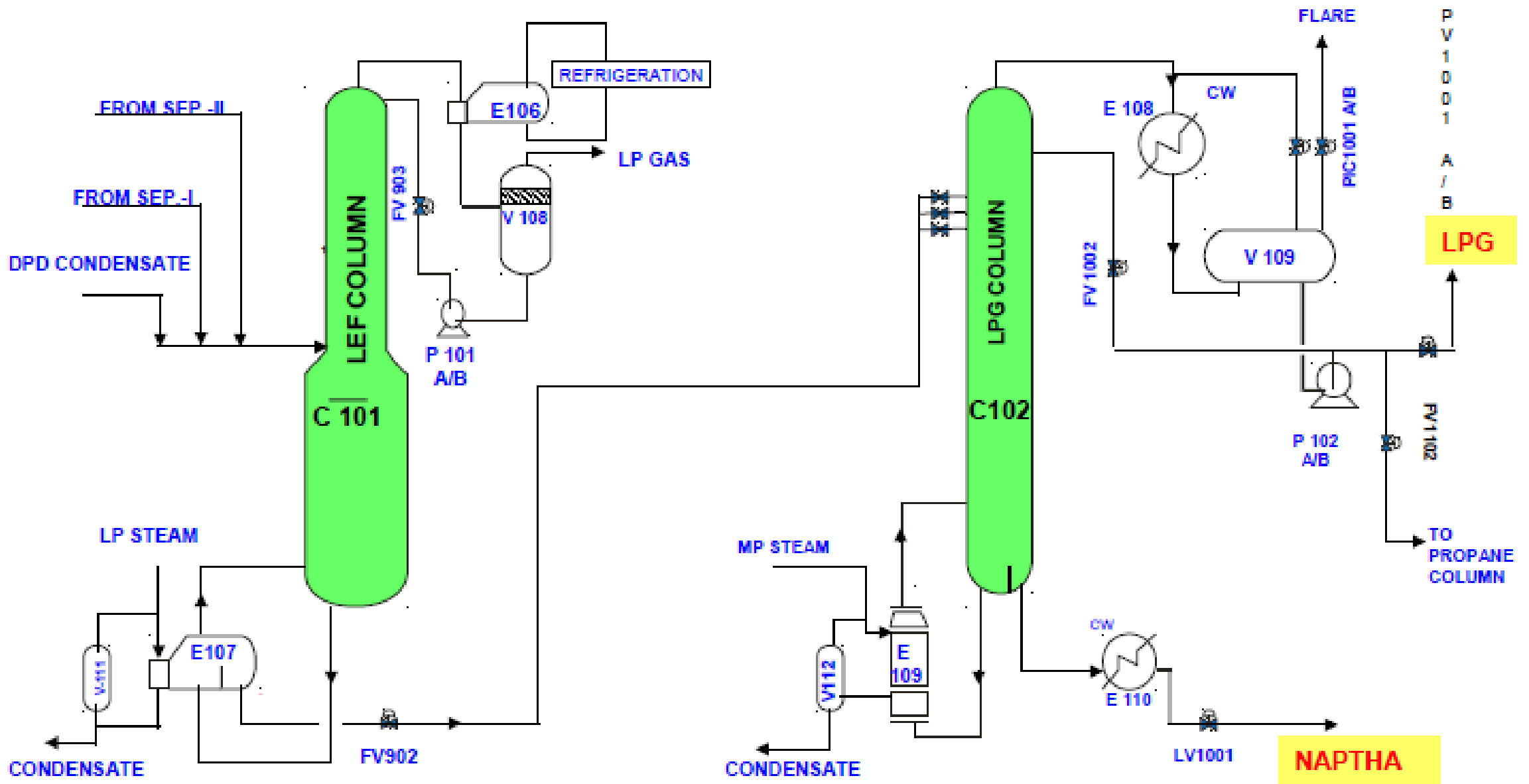

PROPANE COLUMN

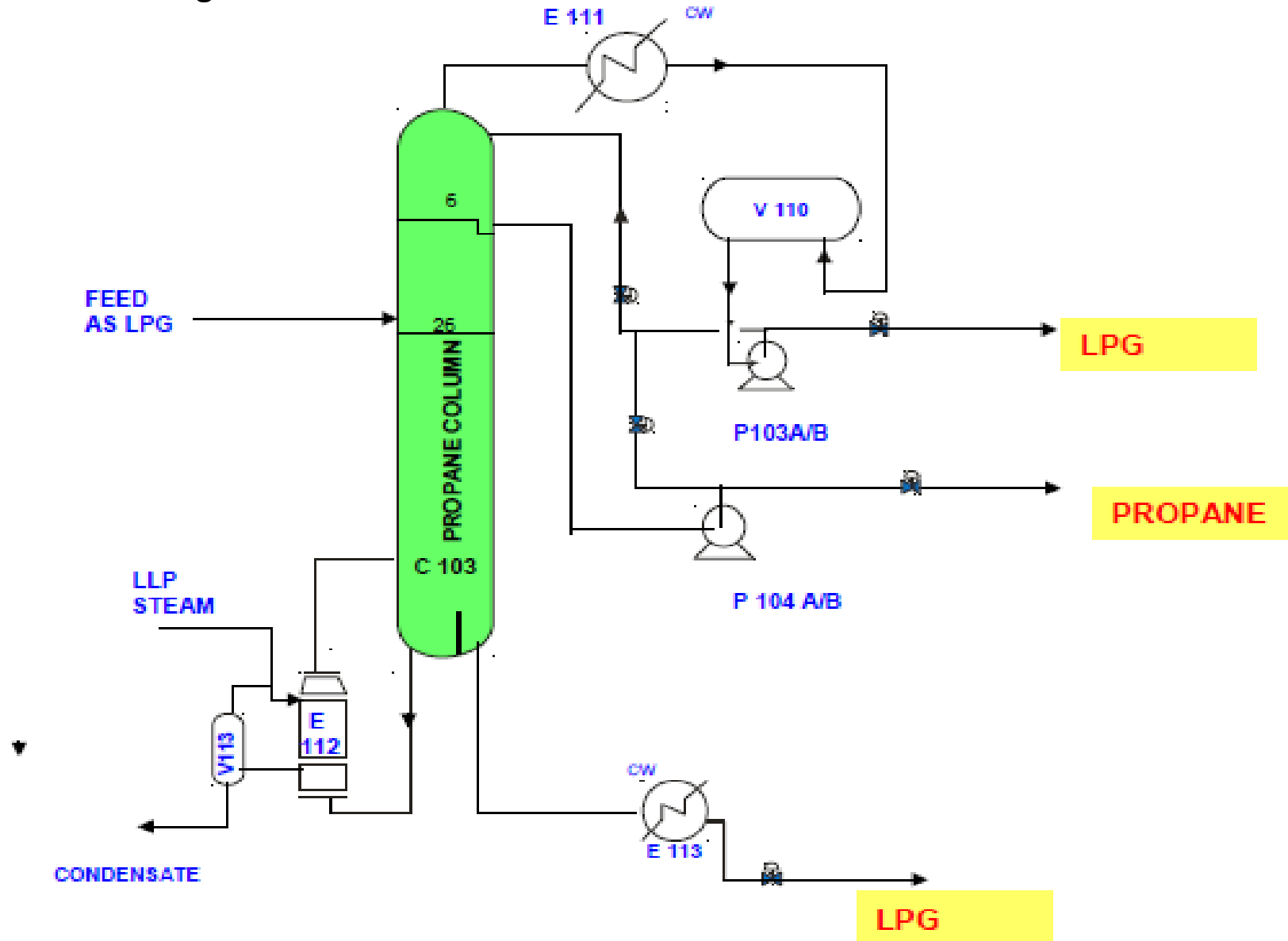

LP GAS & DRYER REGENERATION

IOCL - Hazira LPG Bottling Plant

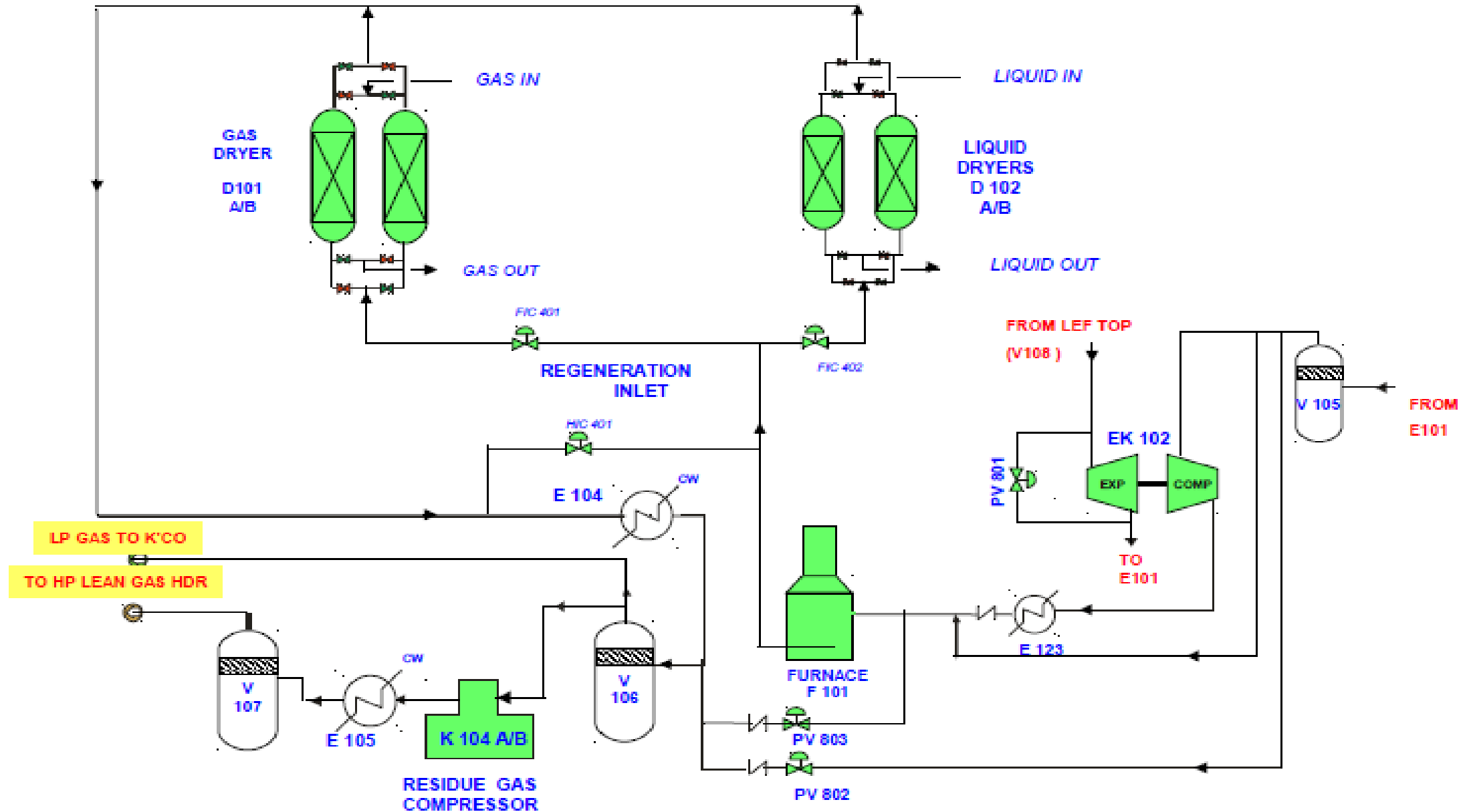

REFRIGERATION SYSTEM FOR LEF TOP CONDENSER E106

IOCL - Hazira LPG Bottling Plant

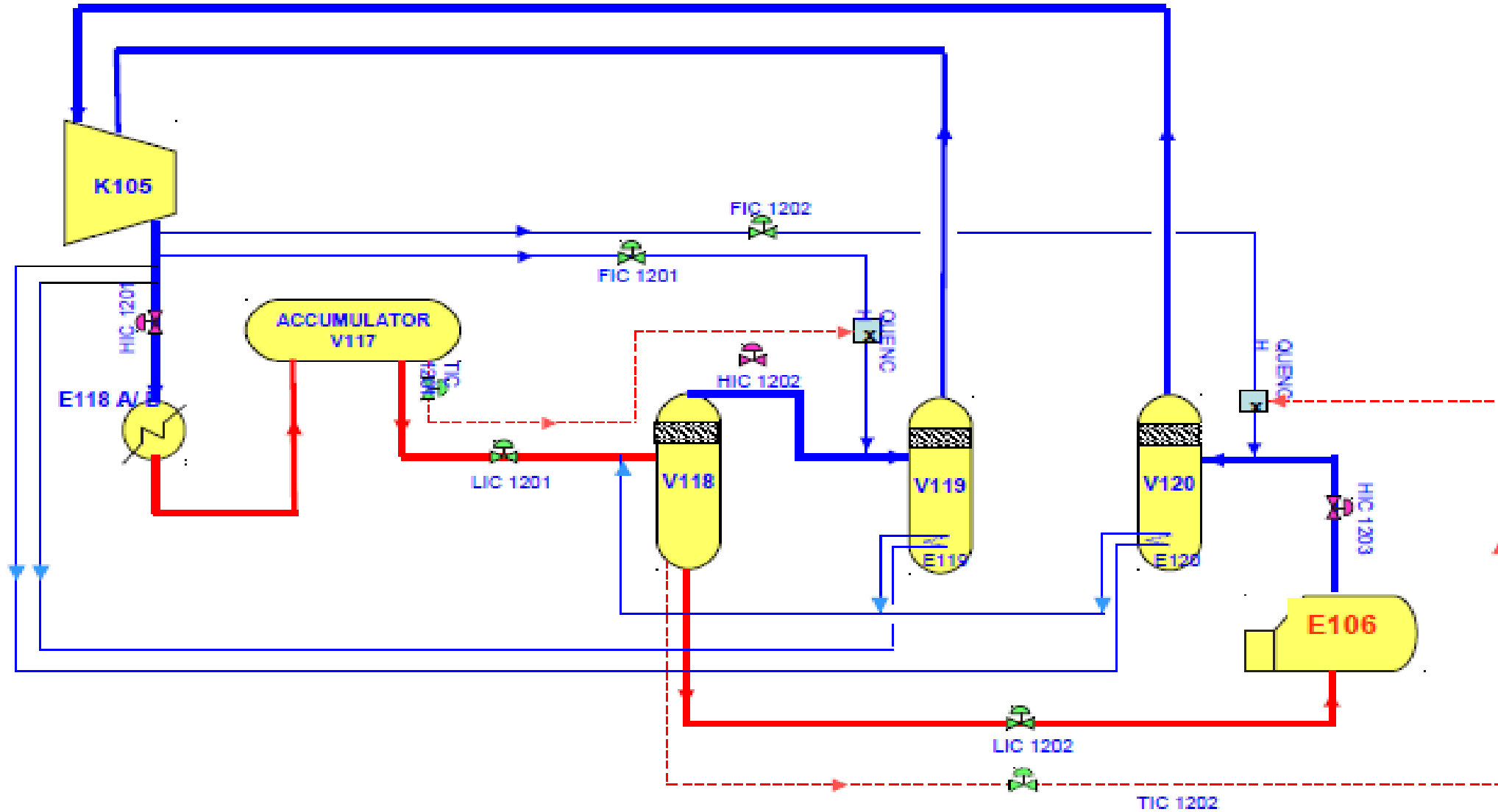

Producer Gas

Producer gas is a low calorific value fuel gas comprising of mainly carbon monoxide and nitrogen.

It is produced by passing air or a mixture of air and steam through a burning bed of solid fuel such as, coal, coke, wood or biomass.

Hydrogen is also present in a significant amount in the producer gas if air-steam blast is used.

The exact composition of producer gas depends on the type of fuel, composition of the blast and operating condition.

Producer gas is formed in a gasifier, called gas producer.

The reactions involved in gas producer are as follows:

1) When only air is used as blast through the fuel bed (air-blast),

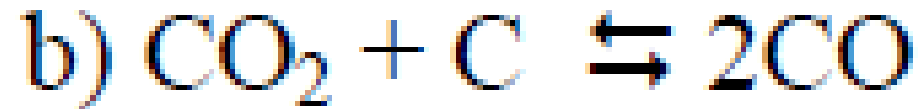

Reaction (a) is highly exothermic and occurs at temperature above 500°C .

Due to heat generation by this reaction, the fuel bed temperature increases.

CO_2 formed in that reaction reacts with carbon of fuel to form CO.

This reaction is named as **Boudouard reaction** and this reaction is important in the sense that the main component of producer gas, CO, is obtained in this reaction. This reaction is endothermic in nature and is favoured at temperatures above 500°C . As a whole the net process is exothermic.

The overall reaction is



The favourable condition for reaction is high temperature, sufficient time of reaction and reactive fuel.

If the fuel contains ash of low fusion point, such as below 1100°C , it melts and resolidifies into the cooler part of the fuel bed.

This is called clinker and it disturbs the uniform burning of fuel and thus the overall efficiency decreases.

The coals having big lumps are also not suitable as a good fuel due to non-uniformity of the bed.

The lumps must be broken into small pieces for getting higher efficiency.

After producer gas is formed in the bed, an opposite reaction to the Boudouard reaction may occur, which is called Neumann reversal reaction, to form CO₂ and C.



2) When steam is used in a mixture of air (steam blast)

At this condition, the above reactions occur (reactions a, b, c, d) and along with those, some other reactions also occur.

Carbon reacts with steam to form carbon monoxide and carbon dioxide by the following reactions,



Both the reactions (c) and (f) are endothermic.

The reaction (e) is active at or above the temperature 1000°C but reaction (f) occurs at the temperature range of 500 to 600°C .

The later reaction (f) is not desirable as it produces CO_2 , which is not a component of producer gas, hence, always the fuel bed temperature is kept high to avoid this reaction.

The excess steam may also react with CO to form CO_2 and H_2 in water gas shift reaction as shown below. This is also an undesired side reaction.



Methanation or methane formation is another side reaction observed.



The above reaction is not favoured at high temperature.

There are several advantages of using **steam blast over air blast**.

In steam blast, hydrogen and methane are the two gaseous components formed which add more calorific value to producer gas.

The endothermic reactions (e) and (f), which occur in steam blast do not allow the fuel bed temperature to shoot up very high, and this way they prevent clinkering of bed to a great extent. Clinkering reduces overall efficiency.

The optimum temperature required for producer gas manufacture is within the range $1100 - 1300^{\circ}\text{C}$.

There is some restriction on the amount of steam also. The endothermic reactions, (e) and (f) occur at a faster rate using large amount of steam, which thereby reduces the fuel bed temperature below 1100°C .

Lower temperature of fuel bed encourages the carbon dioxide formation by the reactions (a), (f).

Steam blast is formed either by injecting steam to the air or passing air through water.

The first process is more convenient to use. The temperature of the air is raised by blowing steam into it upto a desired temperature.

This temperature is called 'blast saturation' temperature.

Gas producer

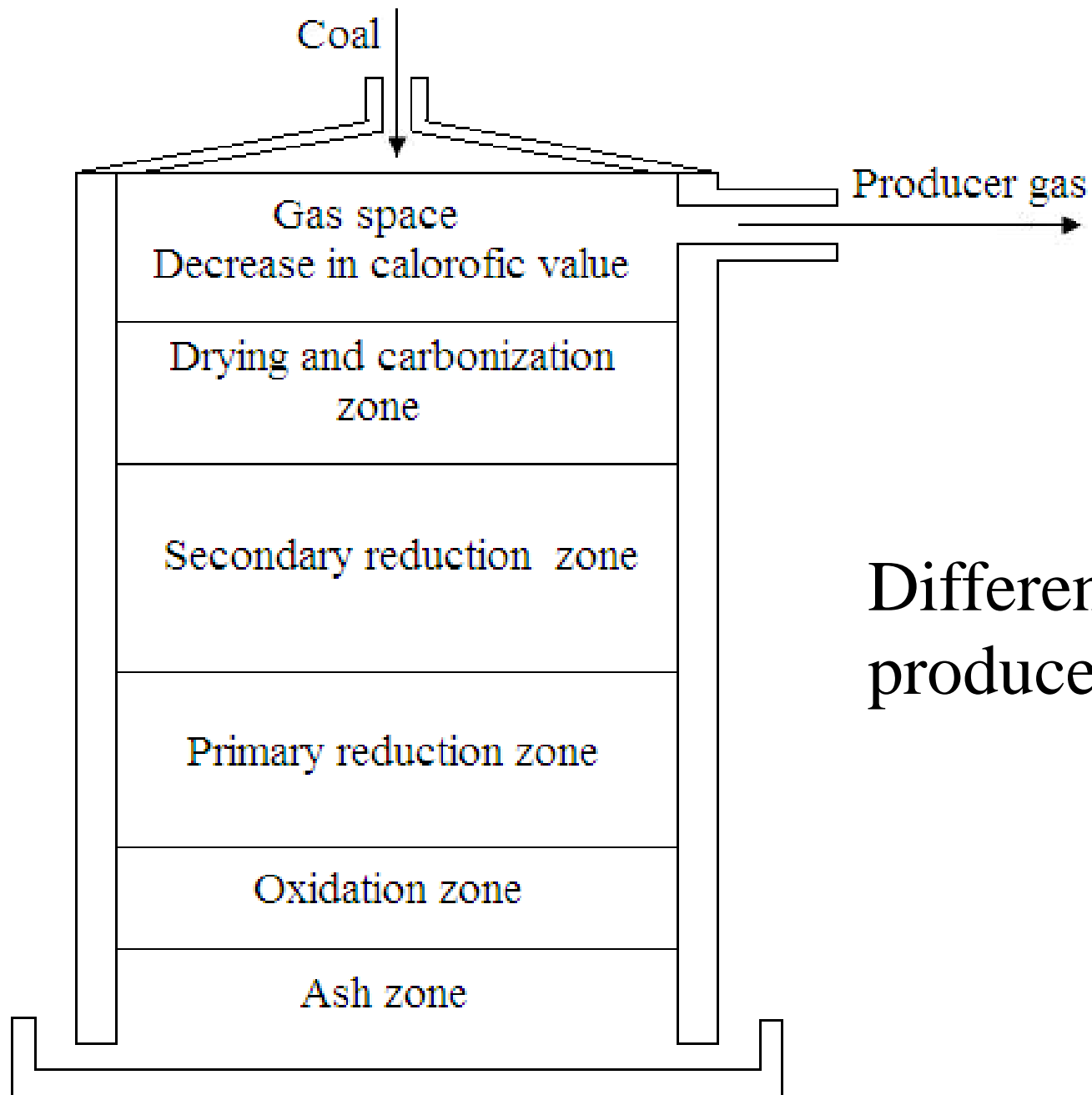

Different reaction zones in a gas producer

In the gas producer, the fuel bed is set on a metallic grate.

Fig above depicts a fuel bed in a gas producer with different reaction zones.

The zones are ash zone, oxidation zone, primary reduction zone, secondary reduction zone and drying zone.

Different reactions occur at different zones of the bed.

In a counter-current movement of air-steam blast and solid fuel, the blast gets preheated at the ash zone.

In the oxidation zone, **carbon dioxide is formed** by the reaction of carbon and oxygen of air.

In the primary reduction zone, several reactions occur which produce **carbon monoxide, carbon dioxide and hydrogen** (reactions b, e and f).

At this stage carbon monoxide formation is quite high.

After this, secondary reduction zone starts where steam reacts with carbon monoxide to **produce carbon dioxide**.

The topmost zone is drying zone where water vapour and volatile matter of the fuel are added to the gas.

Hence, it is observed that, as the gas travels through the bed, its composition goes on changing at each point.

The addition of volatile matter increases the calorific value of the exit gas.

After the gas leaves the bed, it comes to the gas space above the bed.

Here, water gas shift reaction (g) and Neumann reaction (d) occur, where, amount of carbon monoxide decreases.

Hence, the composition of the producer gas is changed and a decrease in calorific value of the gas is observed.

Different types of gas producers are used in industry.

Depending on the direction of fuel and blast movement, the producers are broadly classified as, up-draft, down-draft and cross draft producers.

In these types of producers, the fuels move either countercurrent or concurrent to the flow of gasification medium (steam, air or oxygen) as the fuel is converted to fuel gas.

They are relatively simple to operate in a fixed bed process.

In an updraft fixed bed producer, the flows of the fuel and gases are countercurrent to each other.

The reactive agent, i.e air-steam blast is injected at the bottom of the reactor and ascends to the top while the fuel is introduced at the top and descends to the bottom through zones of progressively increasing temperatures (drying, secondary reduction, primary reduction and oxidation).

Heat from the primary reduction and oxidation zones rises upward to provide energy for the next zones.

Gases, tar and other volatile compounds are distributed at the top of the reactor and increase the calorific value of producer gas, while ash is removed from the bottom.

In case of downdraft producers, the locations of the zones are reversed.

The fuel is introduced at the top, and the reactive agent is introduced through a set of nozzles on the side of the reactor.

Producer gas leaves from the bottom of the producer.

Cross-draft producers exhibit many of the operating characteristics of downdraft gasifiers.

Air or air/steam mixtures are introduced into the side of the gasifier near the bottom, while the producer gas is drawn off on the opposite side.

Producer gas has a very low calorific value in the range of 1000 to 1200 Kcal/Nm³.

Applications include the use of it as fuel for industrial kilns and heat treatment furnaces, such as those found in steel plants.

Producer gas is also usable in plants that melt zinc for use in galvanizing processes and for melting metals, such as aluminum and copper.

It is used for heating open hearth furnaces in the manufacture of steel and glass. It is used for heating muffle furnaces and retorts in the manufacture of coke and coal gas.

Water Gas

Water gas is a gaseous fuel generated in the similar way as producer gas, by gasifying incandescent bed of solid fuel with superheated steam.

The gas is mainly composed of an equal proportion mixture of carbon monoxide and hydrogen.

It is a low calorific value fuel; the calorific value is around 2800 kcal/Nm³.

The gas emits blue flame when ignited due to high content of carbon monoxide, hence, it is named as blue water gas.

The reactions involved when steam is passed through the burning bed of coal or coke above 1000°C are,



This reaction is strongly exothermic and temperature falls below 1000°C gradually with the progress of the reaction.

At lower temperature steam starts to react with carbon to form carbon dioxide, according to the following reaction,



As carbon dioxide does not contribute to the calorific value of water gas, the above reaction is undesirable.

To prevent the formation of carbon dioxide and to lower the cost of the process by not supplying heat from outside to the fuel bed, the whole process of water gas generation is divided into two stages,

a) **Blasting period, when fuel bed is heated up by passing air through it by the exothermic reaction,**



Carbon dioxide formed in this reaction is converted into carbon monoxide by the reaction with the carbon of the solid fuel as the temperature of the fuel bed rises.

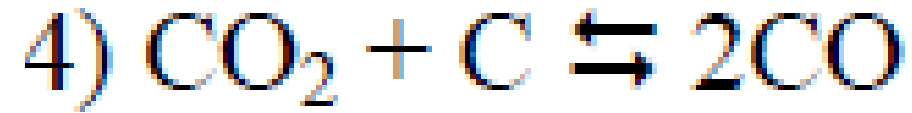

b) Run or gas-making period, when blue water gas is produced by passing steam through the incandescent bed of coal.

At this period, along with the reactions 1) and 2), other reactions such as water gas shift reaction and methanation reaction also occur.

The objective of the blast period is to accomplish only reaction 1) to produce maximum possible heat by this exothermic reaction and the objective of run period is to produce carbon monoxide as much quantity as possible by utilizing maximum amount of steam.

Both these objectives keeping in consideration, a fuel bed with moderate thickness is used, with enough contact time of steam with the bed.

In practice, the rate of decomposition of steam and the formation of water gas are controlled by alternate blast and run period.

As soon as temperature falls below 1000°C , steam blast i.e, run period is stopped and air blast period is started to raise the temperature of the fuel up to 1400°C .

When this temperature is attained, the air blast is stopped and steam blast is again resumed. In this way, the process alternated.

After the air blast period is over, the bed is purged with steam for 2 seconds to remove the carbon dioxide formed in the blast period and this way CO_2 is prevented to mix with the blue gas.

This steam is called purge steam.

On the other hand, after the run period, a 2 second air purging is done to remove last trace of water gas present in the generator, before the blast period is started.

The period for which air is passed through the fuel bed is called hot blow.

The run period is carried out for 3 min and this period is also called cold blow. The hot blow is done for about 1 min.

In the modern period, it is aimed to decrease hot blow period and to increase the run period.

Gas generator

The gas generator consists of a refractory brick lined steel cylinder with approximately 3 m dia and 5 m height.

The solid fuel, coal or coke is introduced at the top of generator through an opening, provided with a door.

Two inlet pipes with valves are fitted at the left side of the generator, where, one pipe is below the top and the other is above the bottom.

Air blast is introduced through these pipes. Steam is passed through two sets of steam pipes, one set is located at the upper region and another set is at the lower region of the generator.

The cyclic operation runs according to the following:

- a) **Up-stream period:** At this period, steam is blown through the lower set of steam pipes and passed upward through the hot fuel bed to generate water gas. This period is carried out for 1.5 min. Water gas produced goes out from the generator by an outlet pipe located at the top.
- b) **Down-stream period:** This period also takes 1.5 min. Steam is blown downward through the upper set of steam pipes to the fuel bed. The water gas produced leaves the generator through a pipe at the base. This pipe is connected to a vertical pipe which is again attached to the outlet pipe. So, water gas formed goes out of the generator through the outlet pipe.

c) The three minute run period (up-stream + down-stream) is followed by one minute purge with air to remove the remaining water gas and send that to the gas holders.

d) After the air purging, air blast is sent through the bed to increase its temperature up to 1400°C.

This operation takes about 2 min. Carbon dioxide formed at this stage passed out through the top valve and thrown as waste.

Carbureted water gas

Water gas is a low calorific value fuel gas.

To increase its calorific value, water gas is carbureted by adding gaseous hydrocarbons obtained by cracking petroleum oils.

In addition to the gas generator, a carburetor, a superheater with purifiers, scrubbers and condensers are used to produce carbureted water gas.

Carburetor and superheaters are the two big steel vessels, lined with refractory checker bricks to provide intensive heat transfer surface.

The gas produced at the air blast period contains large amount of heat which is passed through these vessels to heat the top and side walls and then escape through a chimney to waste heat boiler for raising steam.

Water gas produced during the run period in the gas generator is passed to the carburetor at the top and hydrocarbon oil is sprayed through atomizer into the red hot fire brick.

The sprayed oil in the carburetor is cracked.

The products of cracking and the water gas pass down the carburetor and enter the superheater at its bottom.

The gas mixture rises up through the superheater and the cracking process is completed at this stage.

Some tar produced during cracking is separated in a separator. The gas then passed through a series of pipes cooled by water spray.

After cooling, the gases are led to the purifiers and finally to the gas holders.

In purifiers, hydrated ferric oxide and lime impregnated wood shoring are placed which remove hydrogen sulfide as iron sulfide. The calorific value of carbureted water gas is approximately 4500 kcal/Nm³.

The composition of carbureted water gas is as follows:

H₂: 34-38%,

CO: 23-28%,

saturated hydrocarbons: 17-21%,

unsaturated hydrocarbons: 13-16%,

CO₂: 0.2-2.2% and

N₂: 2.5-5%.

RENEWABLE ENERGY

All fossil fuels are non renewable, and as such they will eventually be depleted.

As they are based on finite resources and their distributions are heavily localized in certain areas of the world, they will become expensive.

Further, energy generation from fossil fuels require combustion, thus damaging the environment with pollutants and greenhouse gas emission.

In order to sustain the future of the world with a clean environment and non depletive energy resources, renewable energy is the obvious choice.

Renewable energy sources include: solar energy, wind energy, geothermal energy, biomass, and hydrogen.

Most renewable energy, except for geothermal energy, comes directly or indirectly from the sun.

Benefits of renewable energy are numerous and they include

1. Environmental cleanness without pollutant emission
2. Nondepletive nature
3. Availability throughout the world
4. No cause for global warming
5. Waste reduction
6. Stabilization of energy costs
7. Creation of jobs

Discovery of Hydrogen

- In 1671, Robert Boyle described the reaction between iron filings and dilute acids which resultant produce the hydrogen gas.
- In 1766, Henry Cavendish was the 1st to recognise hydrogen as a discrete substance.
- He named the gas as “flammable air”.
- Cavendish studied the properties of hydrogen as an element.

Timeline and isotopes

- Lavoiser did the 1st preparation of H₂ using steam flux on metallic iron.
- H₂ was 1st liquefied by James Dewar in 1898 and solidified next year.
- Its isotope Deuterium was discovered in 1931 by Harold Urey.
- Heavy water which is deuterium oxide was also discovered by Urey's group in 1932.
- Another isotope Tritium (which is radioactive) was prepared in 1934 by famous physicist Ernest Rutherford, Mark Oliphant and Paul Harteck.

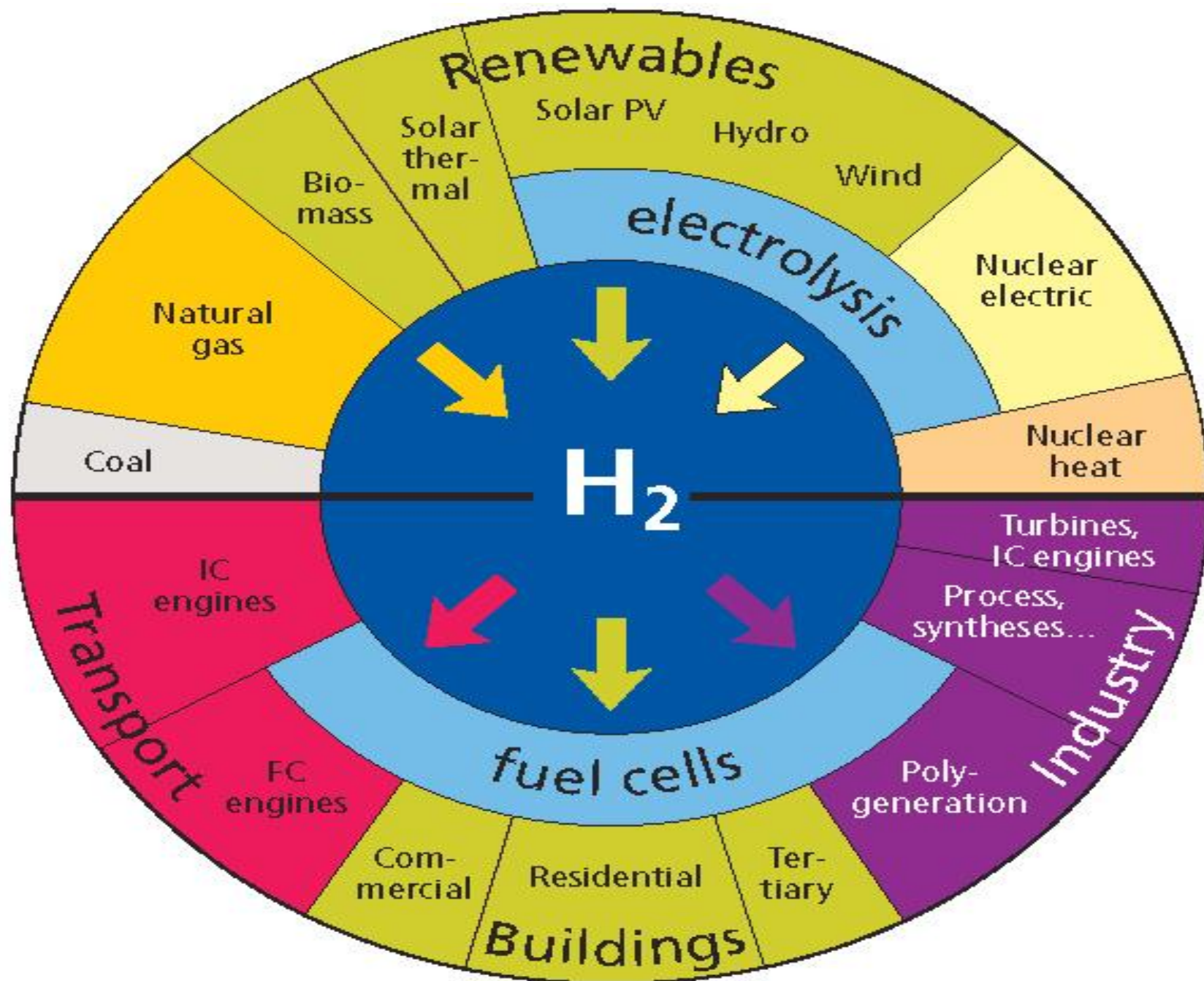



Allis-Chalmers (1959)



Mahindra



Chevrolet Electro van (1966)

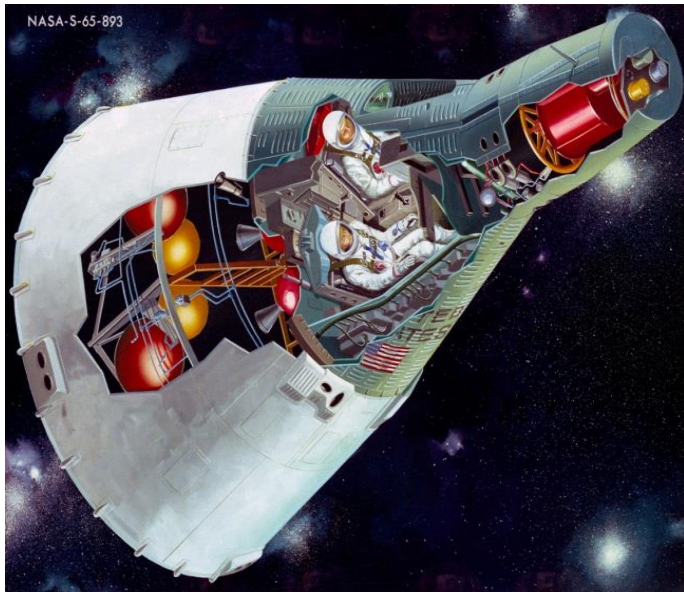

Space Project Gemini (1966)



TATA and ISRO



Mercedes-Benz 2002

- a. It is a colorless, explosive gas with a foul odor.
- b. It is a colorless, odorless and tasteless, explosive gas.
- c. It is a colorless, odorless, tasteless, non-explosive gas.
- d. It is a colorless, odorless, tasteless, poisonous gas.

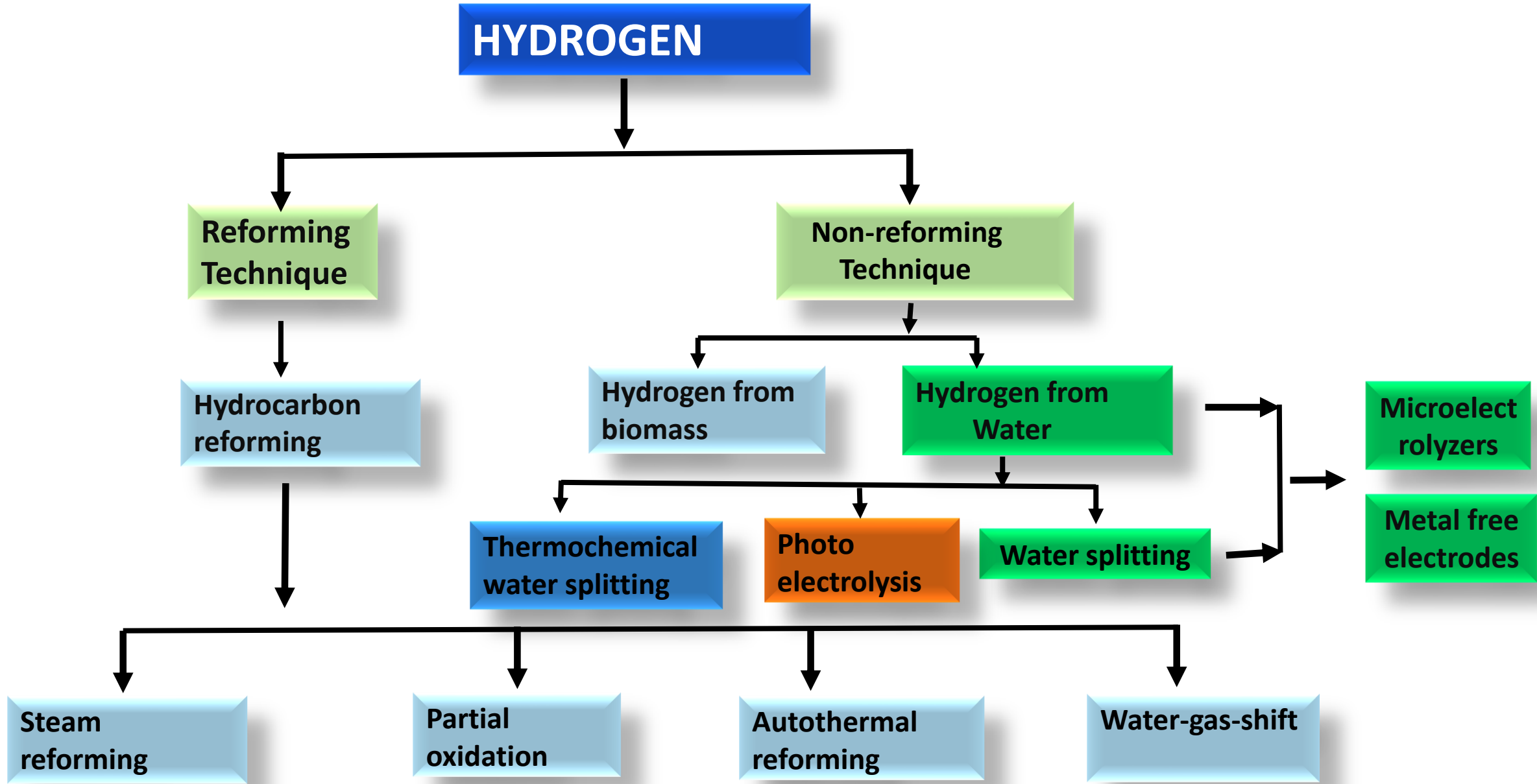

The First Question: Where Does Hydrogen Come From?

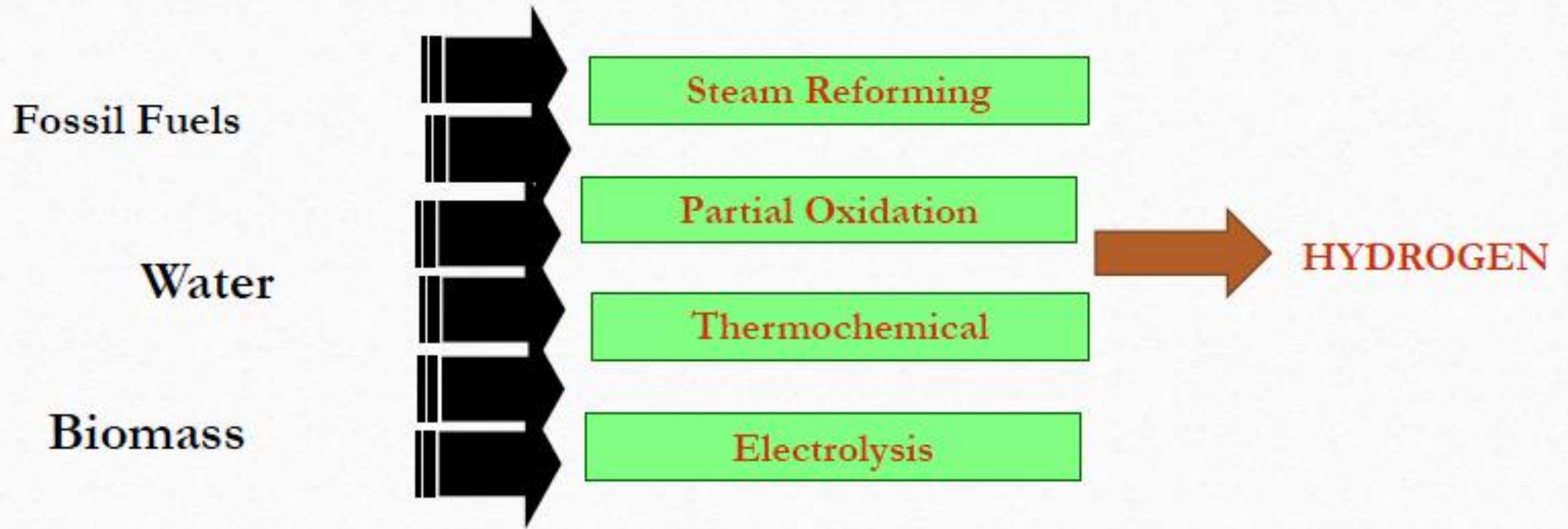

95% of hydrogen is currently produced by steam reforming

STEAM METHANE REFORMING

- It is the process by which natural gas or other methane stream, such as biogas or landfill gas, is reacted with steam in the presence of a catalyst to produce hydrogen and carbon dioxide.
- At high temperatures (700–1100 °C), steam (H₂O) reacts with methane (CH₄) in an endothermic reaction to yield syngas.



- In a second stage, additional hydrogen is generated through the lower-temperature, exothermic, water gas shift reaction, performed at about 360 °C:



Essentially, the oxygen (O) atom is stripped from the additional water (steam) to oxidize CO to CO₂. This oxidation also provides energy to maintain the reaction.

shift reaction

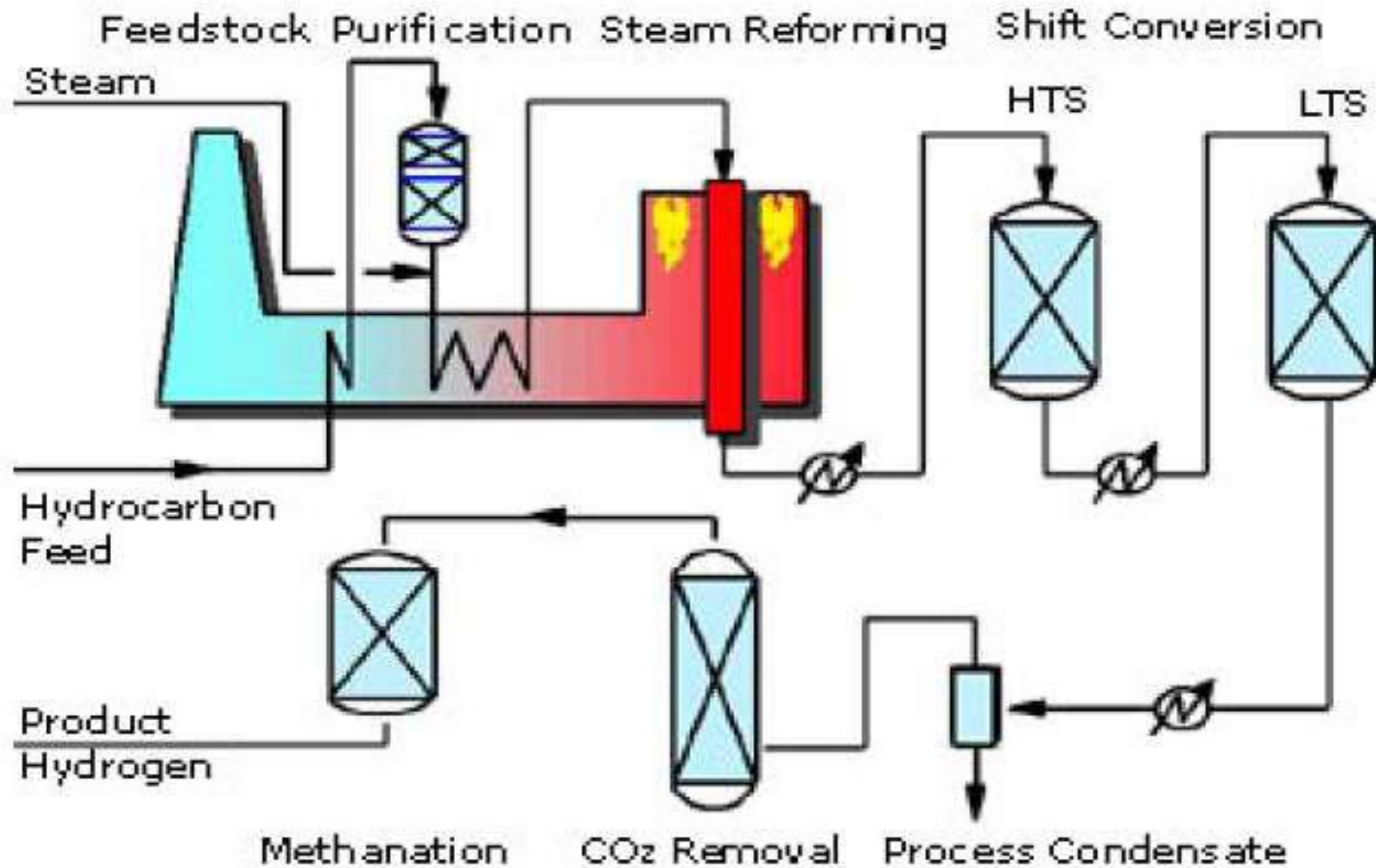

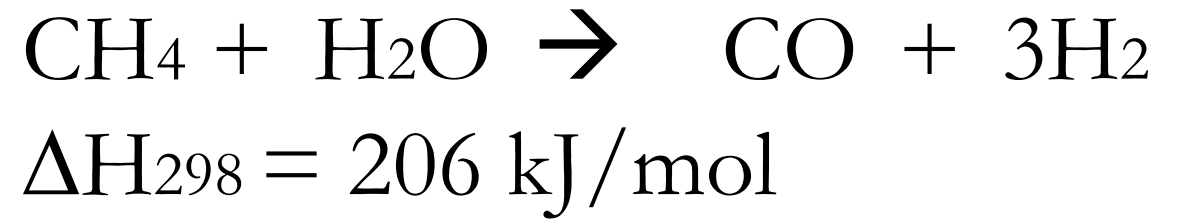
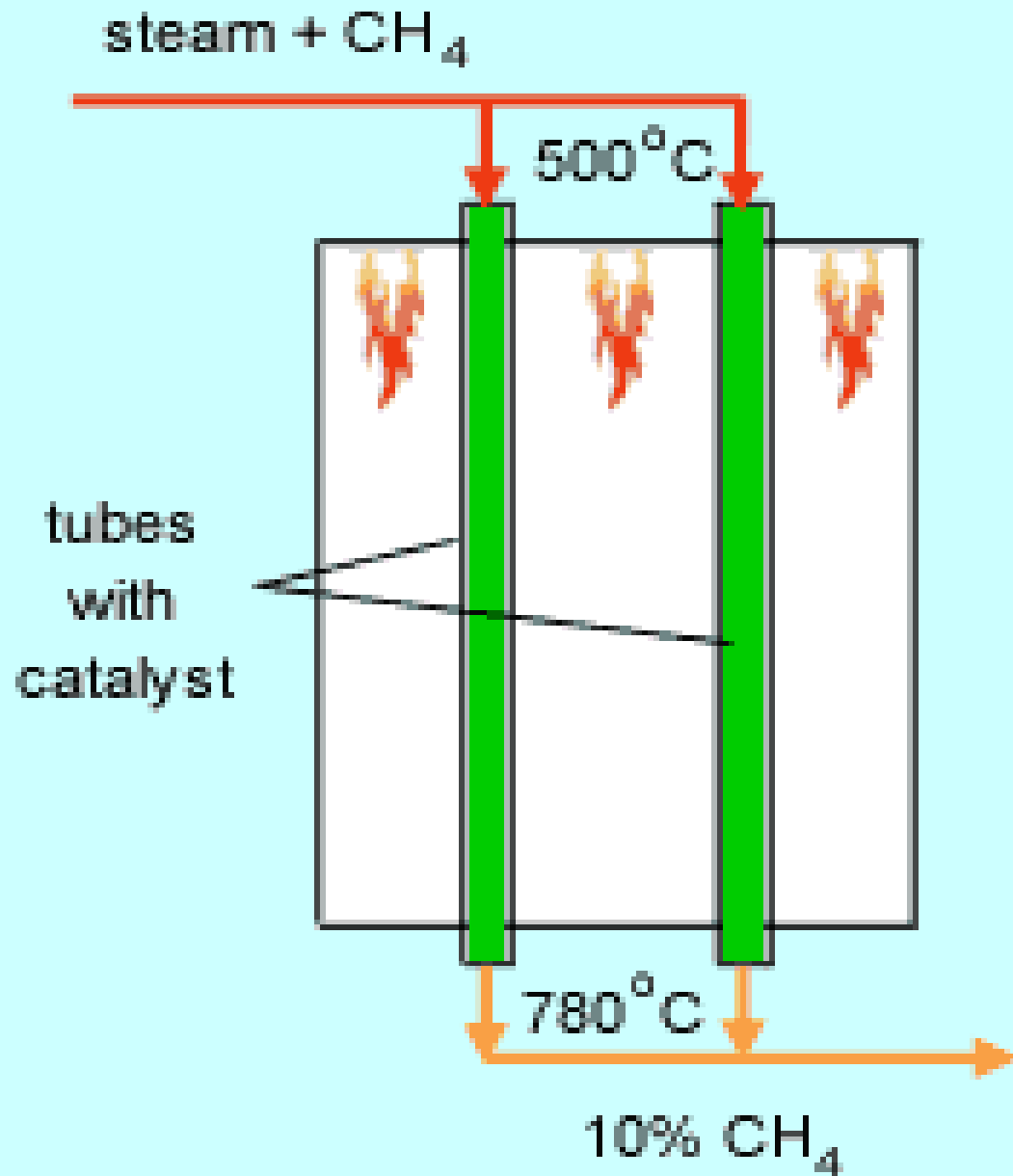

Water gas shift reaction

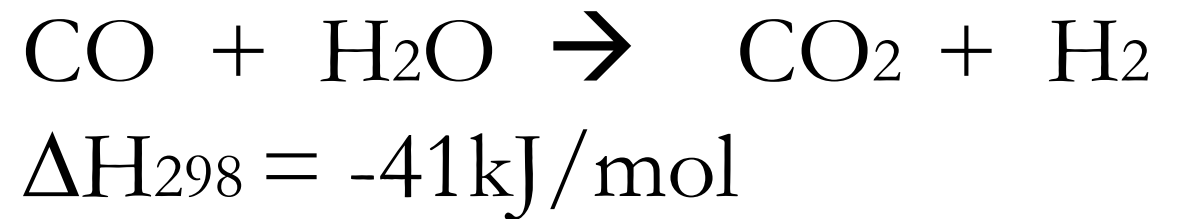

Steam Methane Reforming

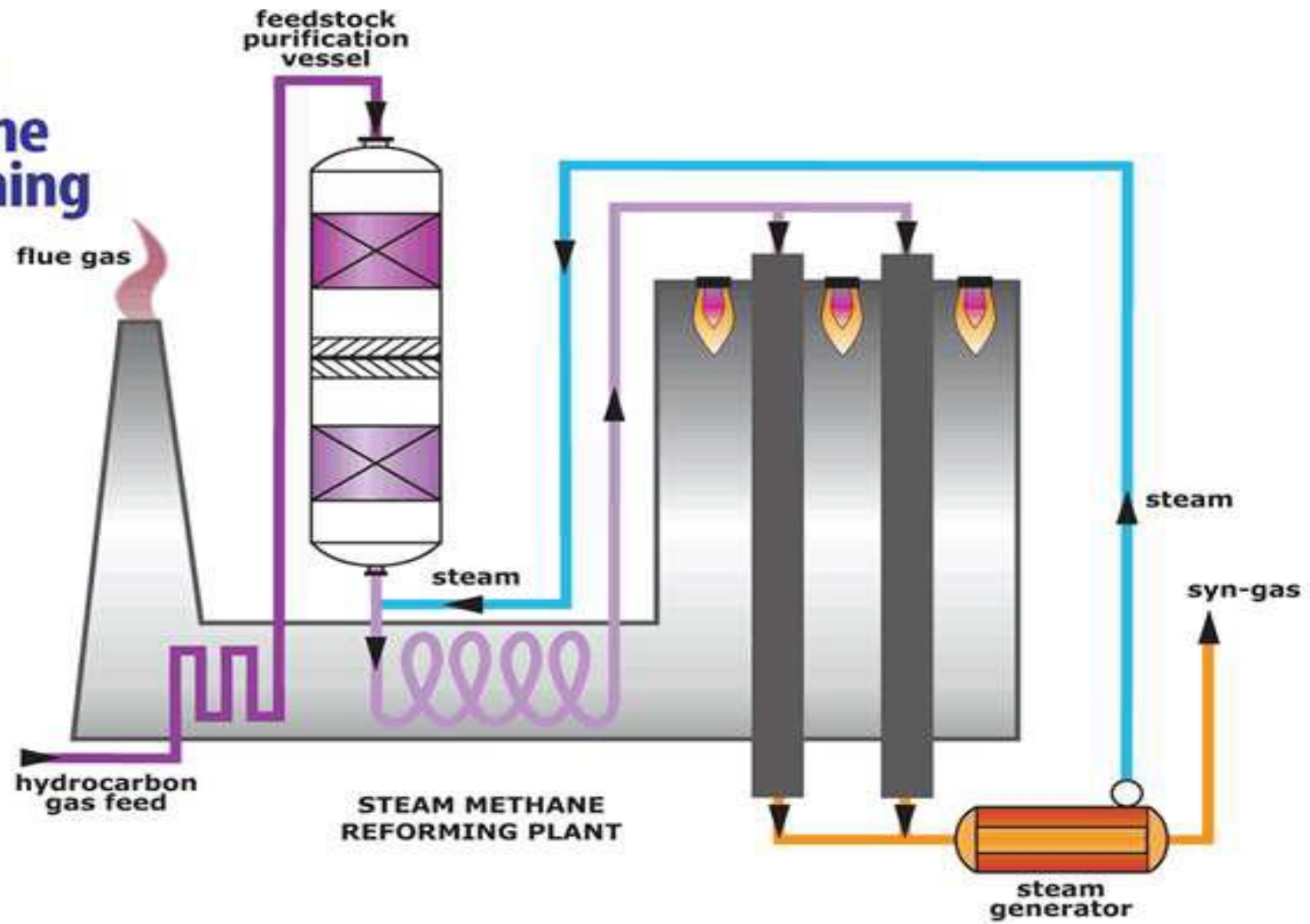

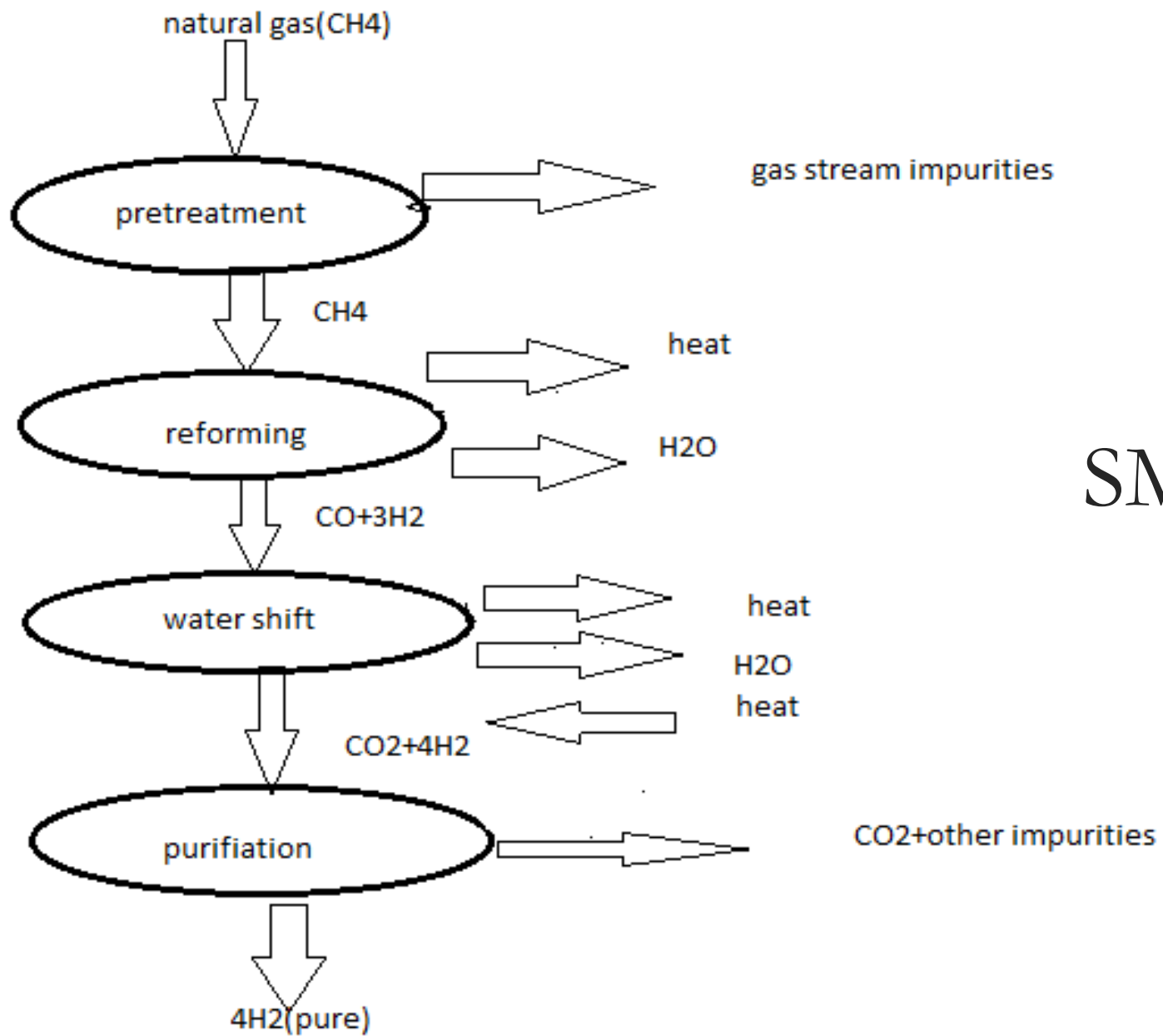

SMR BLOCK DIAGRAM

Anaerobic Corrosion [Schikorr reaction]

- Under anaerobic condition iron alloys are slowly oxidised by protons of water
- Protons themselves get reduced to molecular hydrogen
- This process consist of following reactions-



- Fe_3O_4 is thermodynamically more stable than $\text{Fe}(\text{OH})_2$

Gasification Process

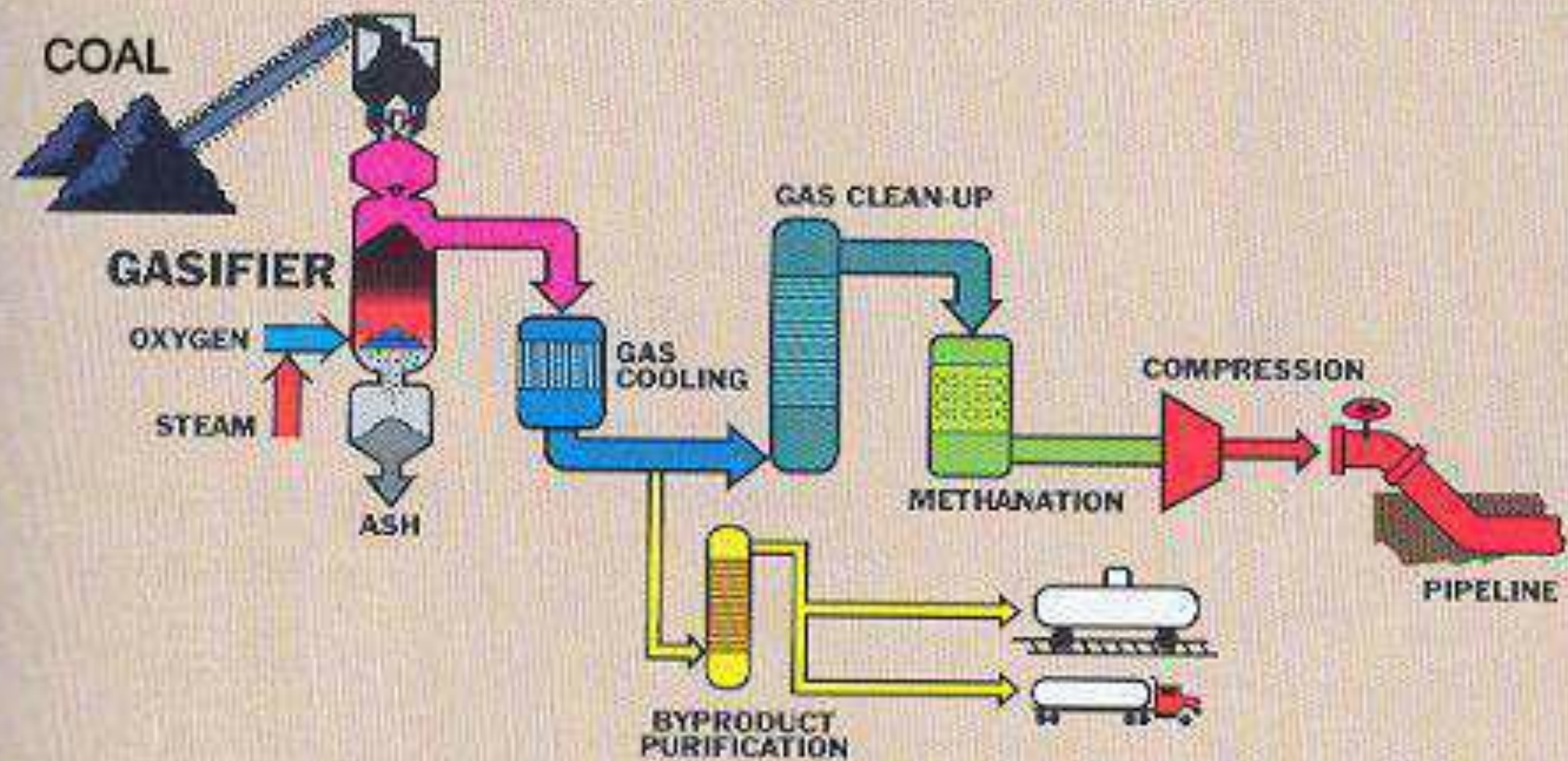

Basic flow diagram of a gasification plant

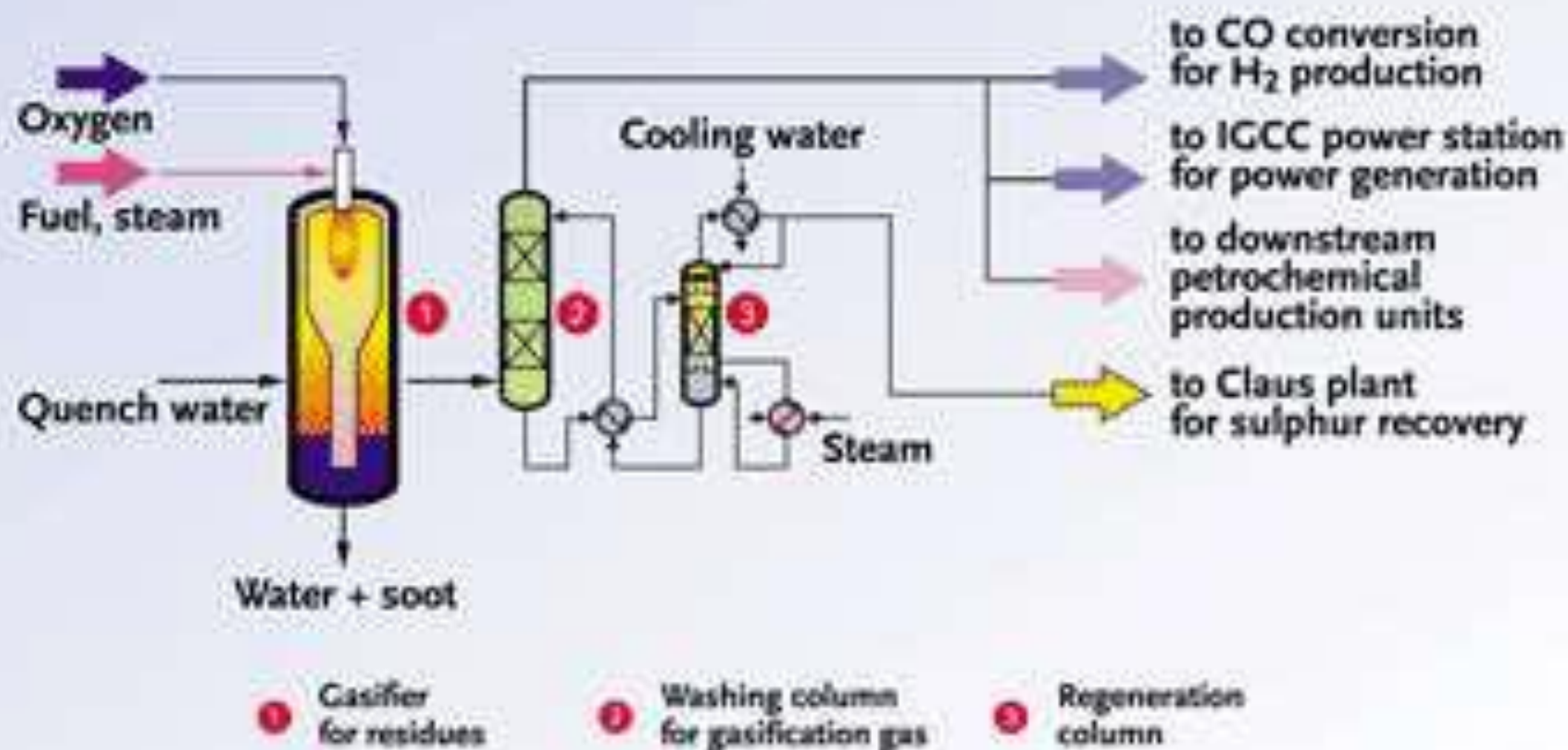

4 Processes in Gasification

not necessarily in order

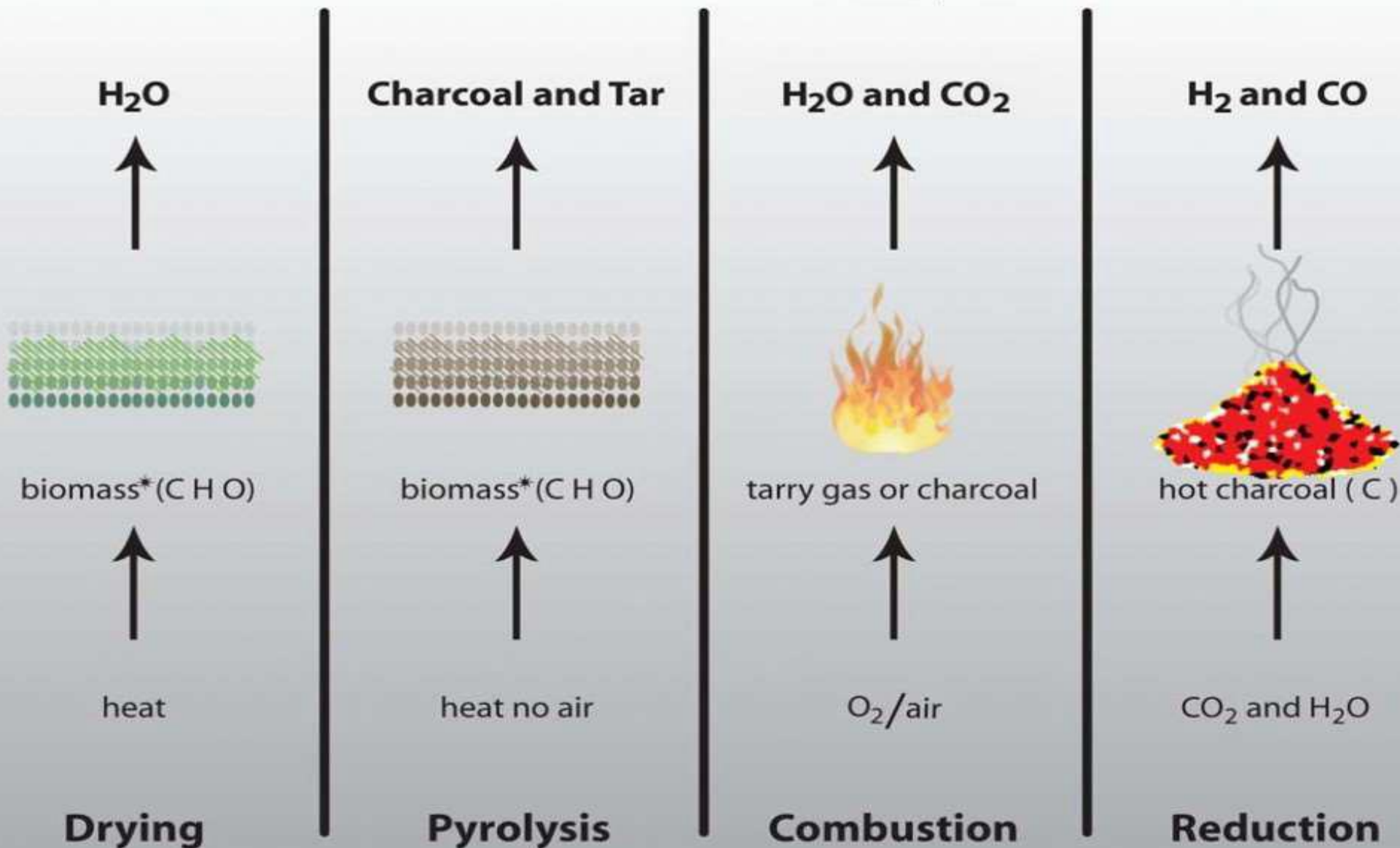

* Biomass is a combination of C, H, and O (C H_{1.4} O_{0.6})

HYDROGEN FROM BIOMASS

- Biomass + O₂ → CO + H₂ + CO₂ + Energy
- Why Biomass to hydrogen?
- Biomass has the potential to accelerate the realization of hydrogen as a major fuel of the future.
- Biomass is renewable, consumes atmospheric CO₂ during growth and is a CO₂ neutral resource in life cycle
- It can have a small net CO₂ impact compared to fossil fuels
- Gasification coupled with water-gas shift is the most widely practiced process route for biomass to H₂.

Photocatalytic decomposition of water

Photoactive metals oxides

Semiconductors

Doped metal
oxides

Metal-oxy-
sulfides/nitrides

Polymers

Concept

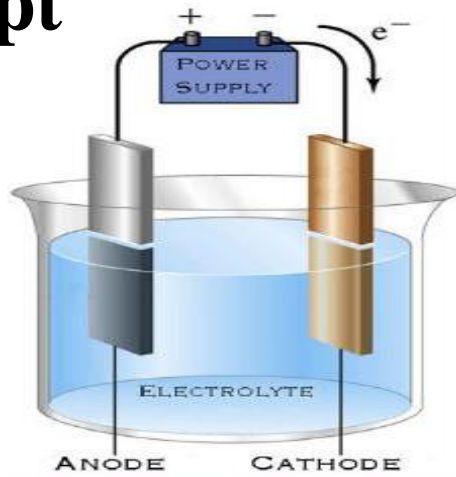

William Nicholson and Anthony Carlisle first did electrolysis of water

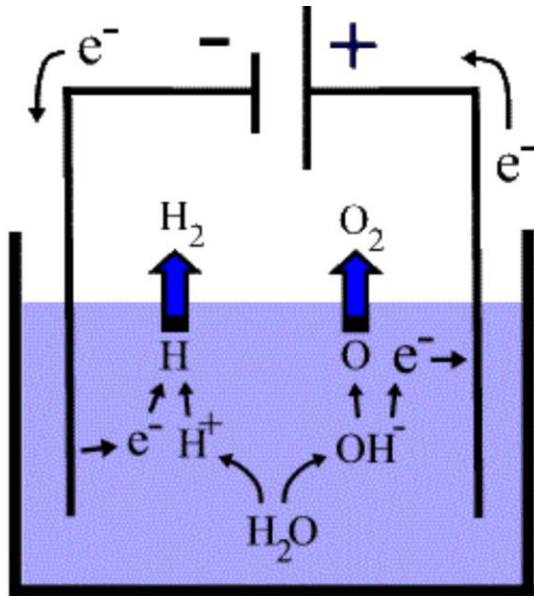

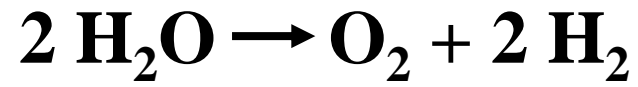

(I) Electron injection to form H_{ad}

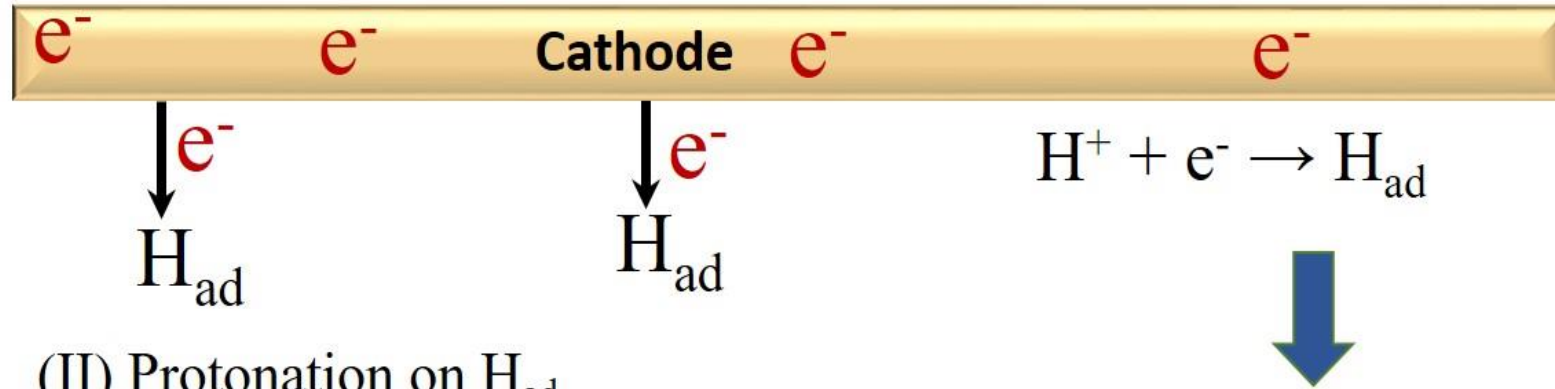

(II) Protonation on H_{ad}

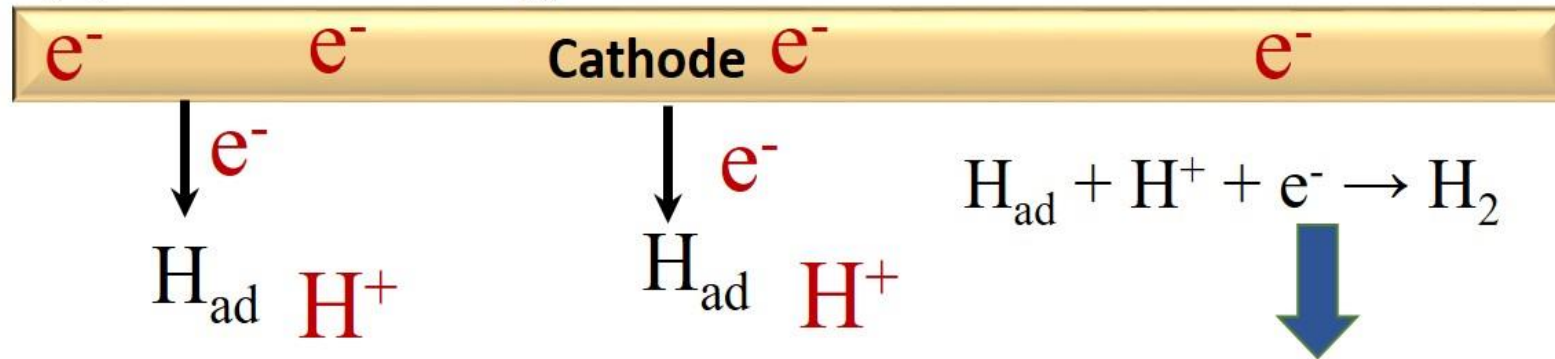

(III) Desorption and hydrogen production

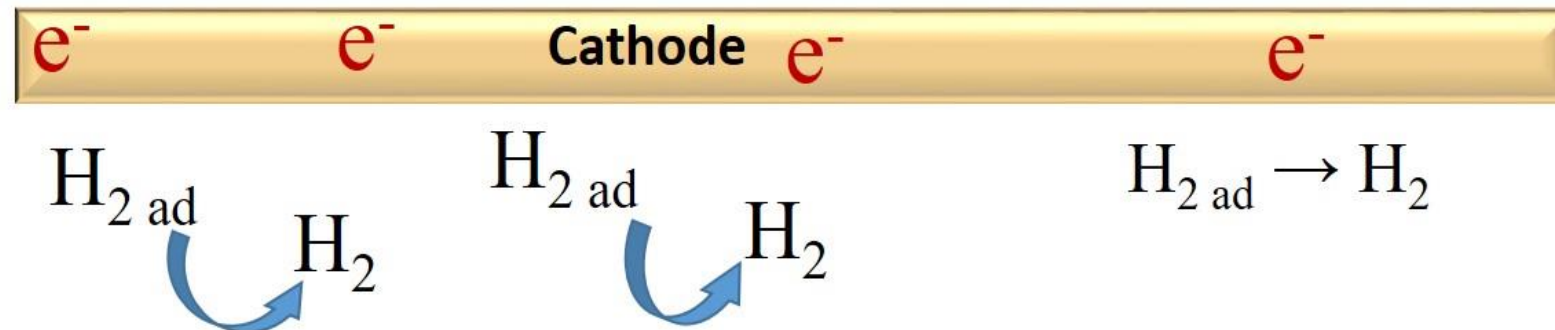

(I) Formation of OH_{ad} on anode

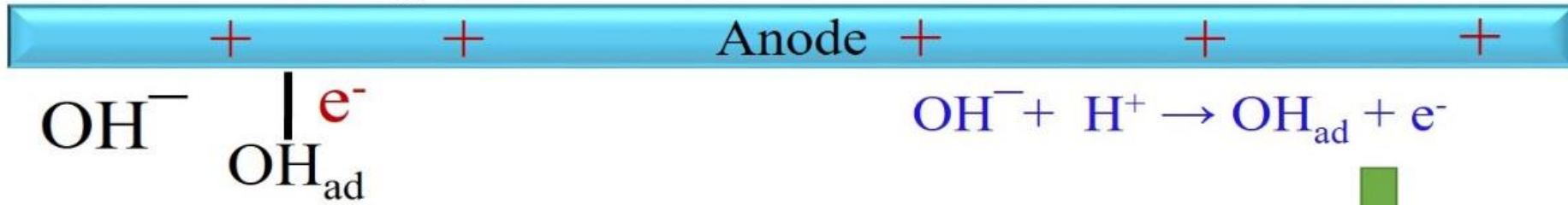

(II) Oxidation from OH_{ad} to form O_{ad}

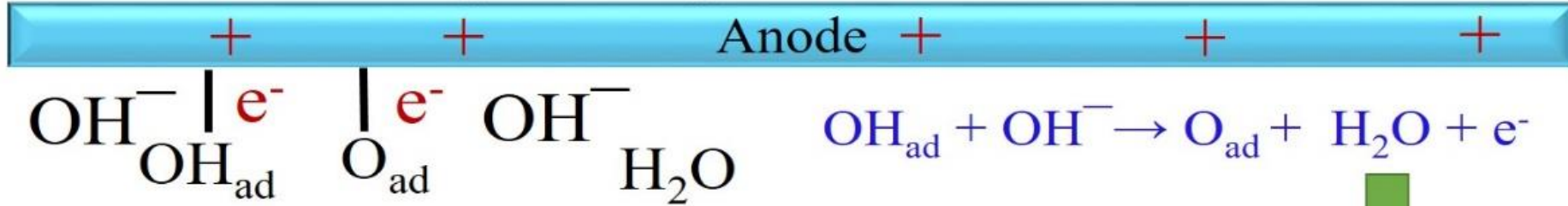

(III) Oxygen coupling step to form OOH_{ad}

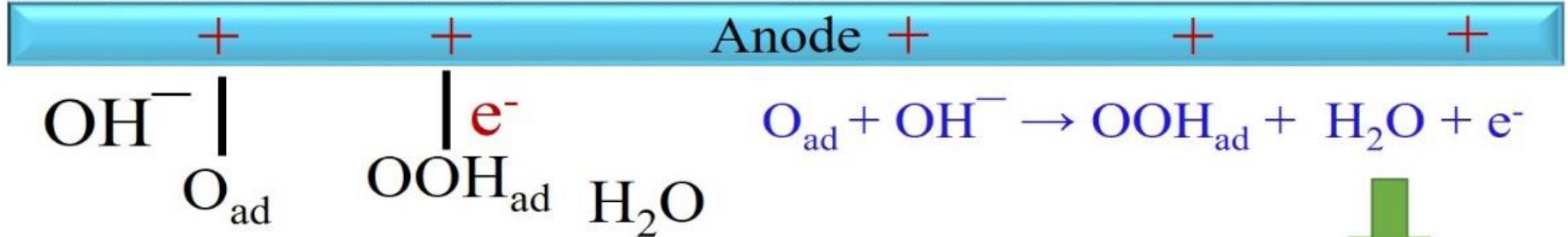

(IV) Formation of adsorbed O_2 and desorption to form O_2

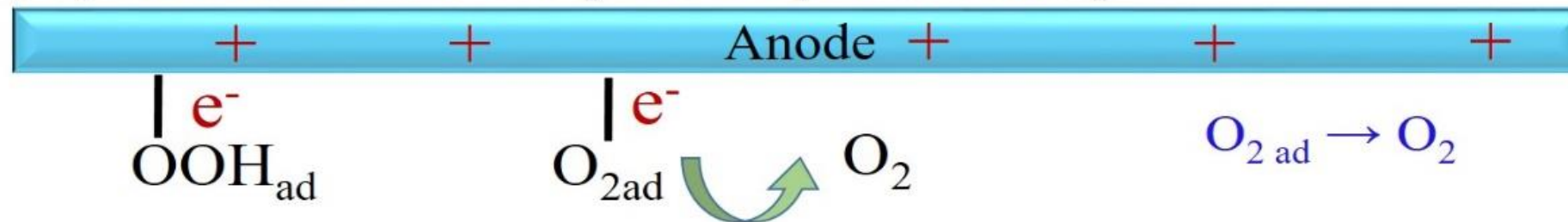

Experiments

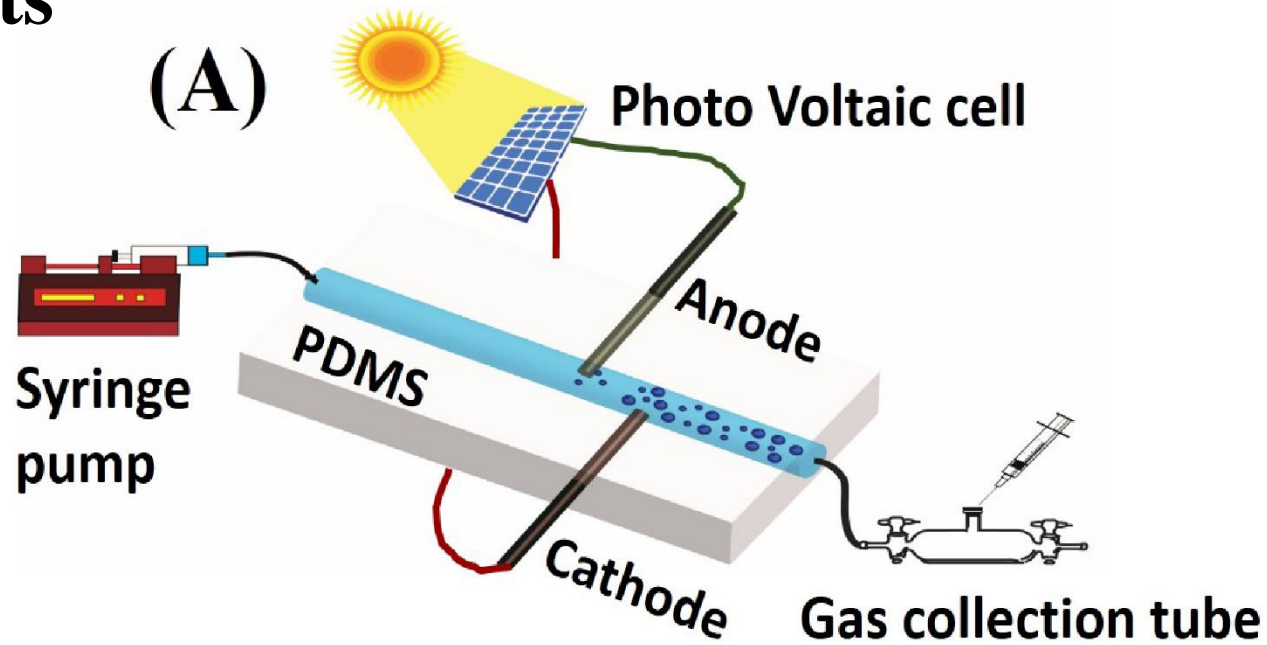

Schematic diagram of the experimental setup

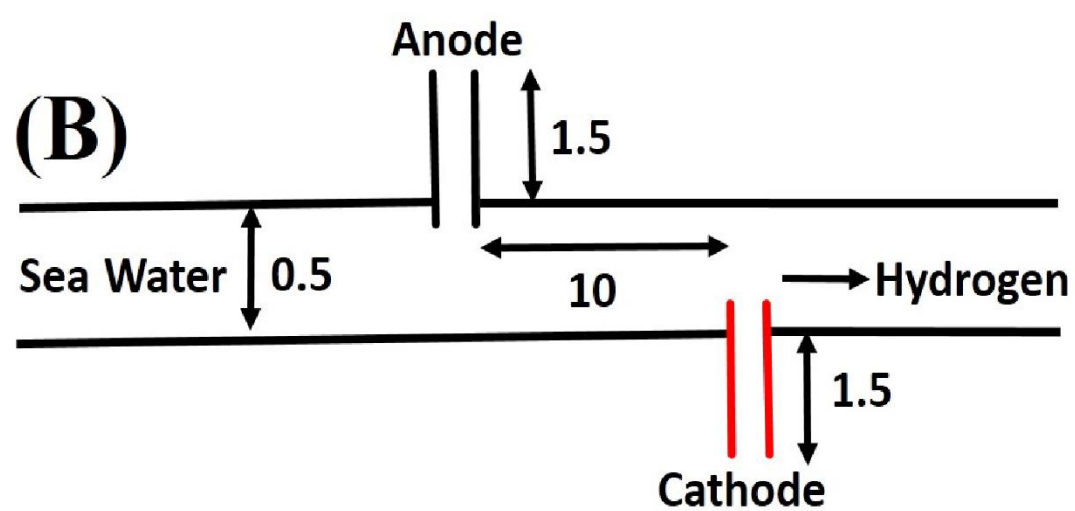

Schematic diagram of the straight microfluidic electrolyzer

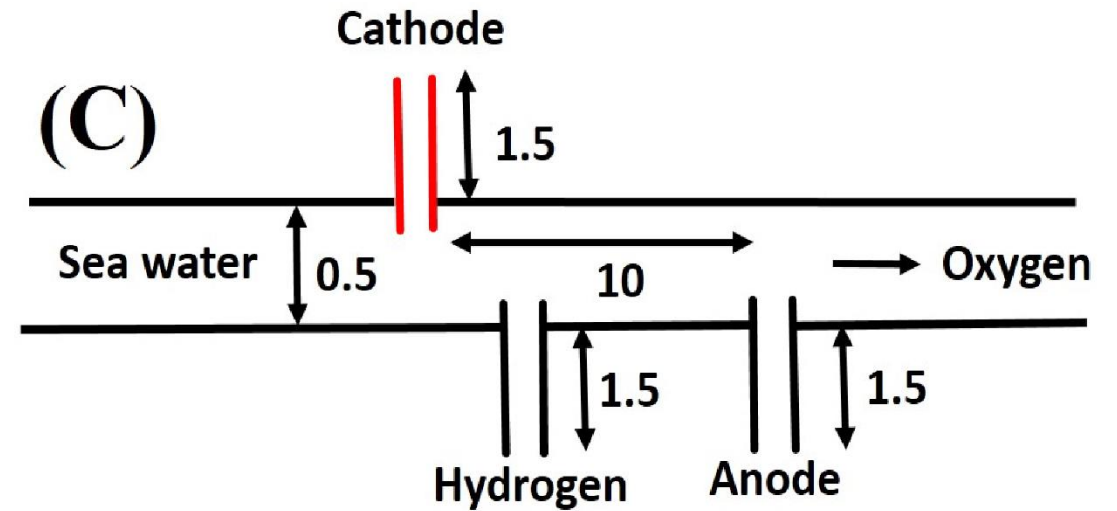

Schematic diagram of the T shaped microfluidic electrolyzer separator

Results and Discussion

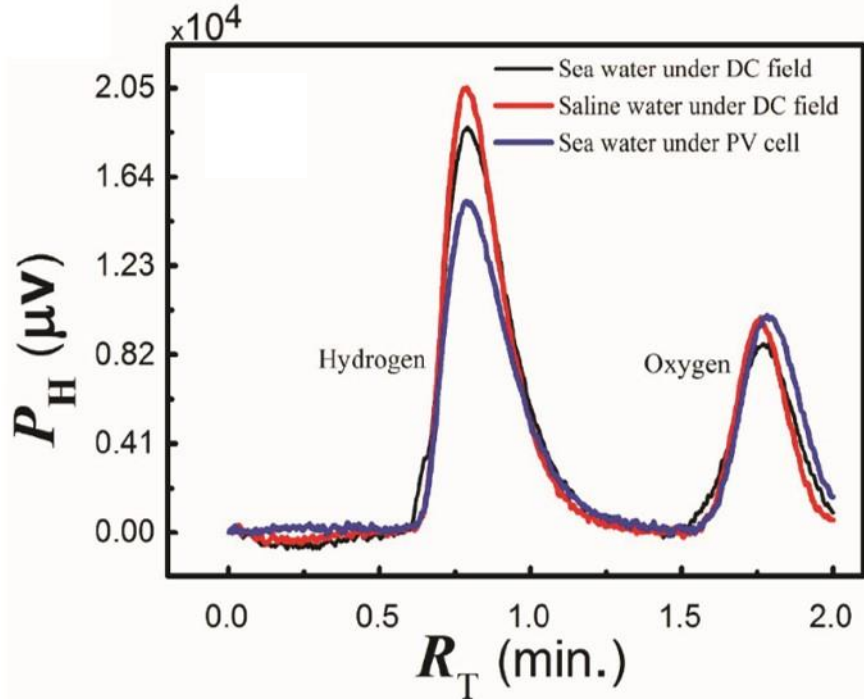

The GC analysis of the gas obtained from the microelectrolyzer

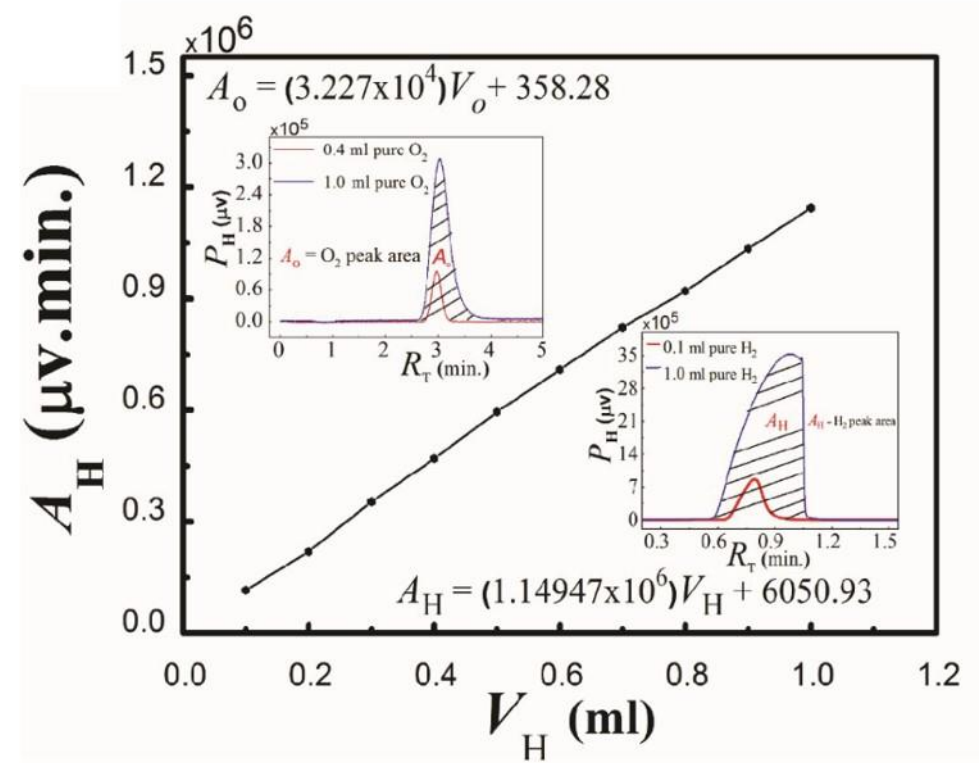

GC calibration plot for hydrogen and oxygen

Video showing the production of hydrogen at various voltage

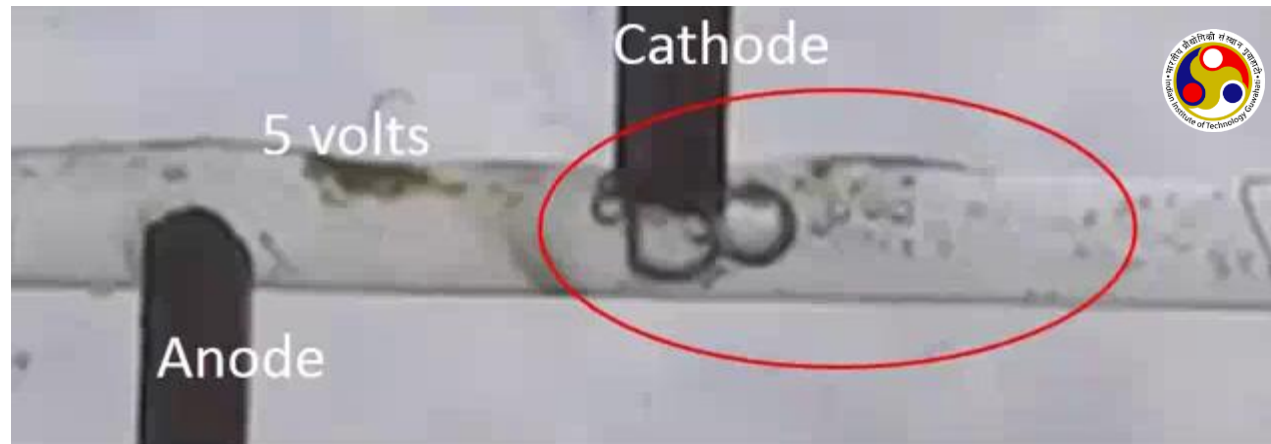

INDUSTRIAL HYDROGEN APPLICATIONS

- Largest application of H₂ is for processing of fossil fuels (hydrodealkylation, hydrodesulphurization & hydrocracking)
- Manufacture of Ammonia, Methanol
- Large amounts of H₂ is used in oil industries for hydrogenation of unsaturated oils
- It is used shielding gas in welding.
- H₂ is used as rotor coolant in electrical generators

Liquid H₂ is used in the Cryogenic studies including superconductivity studies.

- Earlier it was used as lifting gas but after the incident of Hindenburg Disaster this practice was opted out.
- Recently, H₂ is used pure or mixed with N₂ as a tracer gas for minute leak detection in automobile, chemical plants, aerospace etc.
- Hydrogen is an authorised food additive (E949) that allows food package leak testing among other anti-oxidizing properties

Hydrogen safety

- H₂ safety covers safe production, use & handling of H₂
- H₂ poses unique challenges due to
 - *ease of leak* – odourless, colourless & tasteless. Smell additives unsuccessful.
 - *low energy ignition*- order of 0.02 mJ.
 - *buoyancy* – once leaked rises rapidly, v difficult to control.
 - *its ability to embrittle materials*- Enters pipe line and can follow them to their destination.
- Current ANSI/AIAA standards for H₂ safety guidelines is G-095-2004, Guide to Safety of Hydrogen & Hydrogen Systems. These are adopted from NASA world's largest user of H₂.

ADVANTAGES OF HYDROGEN GAS

- *Readily available*- There is no other element in the entire universe as abundant as is H₂
- *No harmful emissions*- As is apparent from the fact that NASA used exhaust from their shuttle as a source of drinking water for astronauts
- *Fuel Efficient*- H₂ has very high calorific value as compared to other fuels(by mass)
- *Very low viscosity makes it ideal as coolant*
- *Non-toxic*- It has no benchmark effect on humans.
- *Renewable*- As we have more than $\frac{3}{4}$ portion of earth as water, there will be no shortage of H₂, we just need to device a method to split it.

DISADVANTAGES

- *Expensive*- The available methods require a lot of energy hence capital input.
- *Storage*- Storage is one the main causes of reluctance of investors in this energy source.
- *Not easy to replace existing infrastructure*- Currently all the machinery is designed to work on the gasoline as fuel, it is said that replacing them to make compatible with H₂ is far expensive than its production.
- *Highly Flammable*- It is a fire hazard, liquid H₂ explodes with intensity comparable to TNT

Solar Energy

Why Solar?

- **Renewable and Abundant**
- **Clean**
Doesn't produce air pollutants or carbon-dioxide
- **Readily Available**
More readily available than other renewable energy resources (wind or hydro)

86,000TW

of the Sun's energy reaches the Earth



Earth's global energy consumption:

15TW

Covering 4% of the world's desert area with photovoltaic could supply the equivalent of all of the world's electricity

-US Energy Information Administration

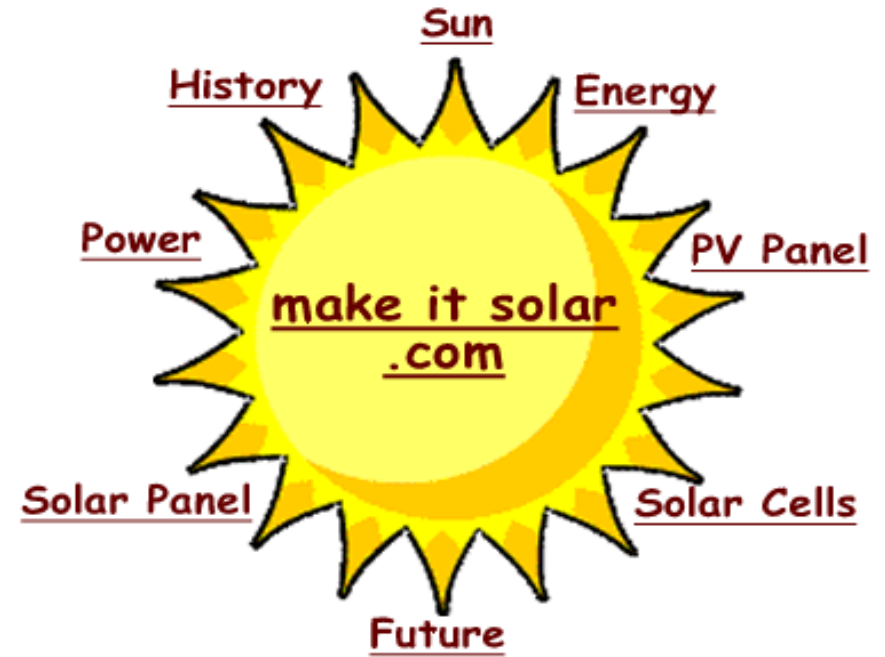

History

- Becquerel observed the photoelectron chemical process

1839

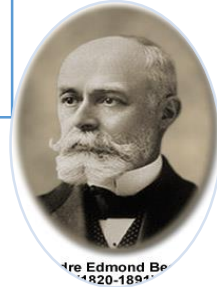

- Best 20 years in the history of PV. first heterojunction PV device, dye/dye bulk heterojunction ,first polymer/C60 heterojunction

1980-2000



- Scientist worked on magnesium phthalocyanines (MgPh) measuring a photovoltage with different electrodes

1900-1980

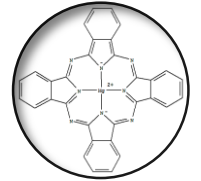

- Advancement in Organic solar cell. Hybrid solar cell Industrialization of solar energy

present

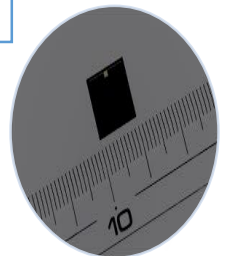

Practical uses

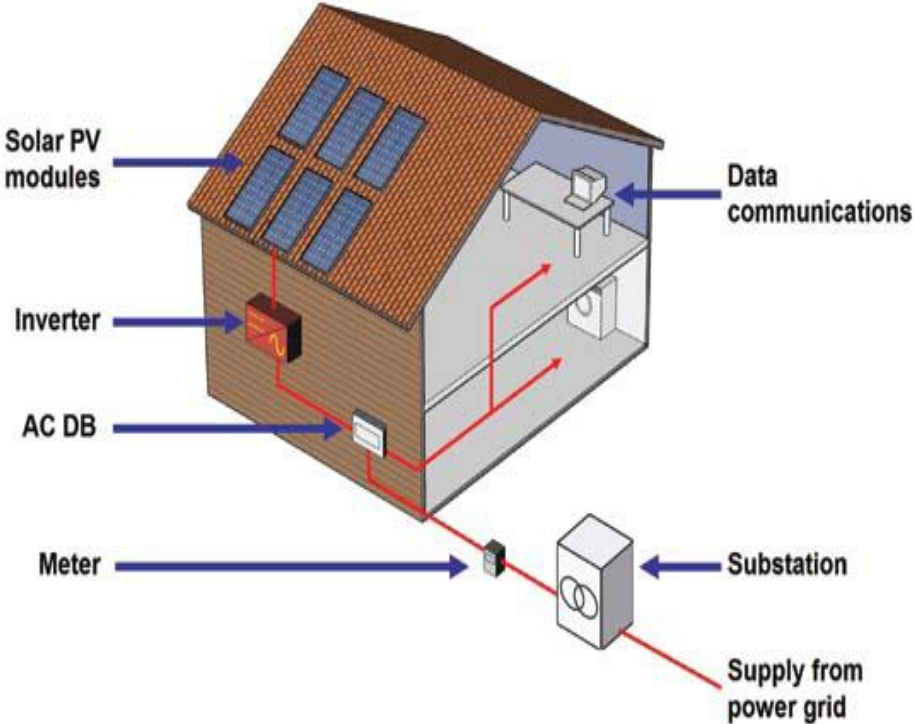

Off-grid solar PV systems

Grid-connected solar PV systems

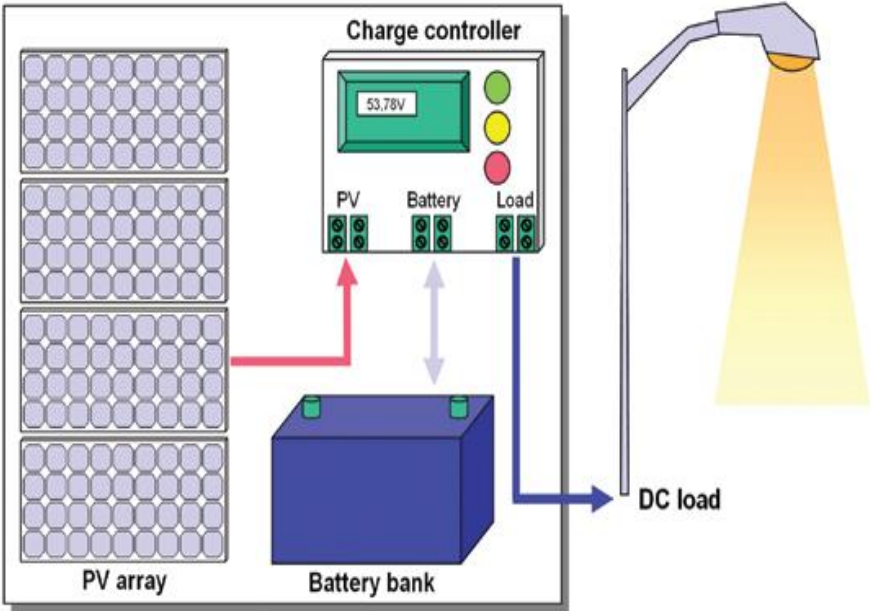

Generations

First Generation

Single crystal silicon wafers
(c-Si)

Third Generation

Nanocrystal solar cells
Photoelectrochemical (PEC)
Grätzel cells
Polymer solar cells
Dye sensitized solar cell (DSSC)

Second Generation

Amorphous silicon (a-Si)
Polycrystalline silicon (poly-Si)
Cadmium telluride (CdTe)
Copper indium gallium diselenide
(CIGS) alloy

Fourth Generation

Hybrid - inorganic crystals
within a polymer matrix

1 H																	2 He
3 Li	4 Be											5 B	6 C	7 N	8 O	9 F	10 Ne
11 Na	12 Mg											13 Al	14 Si	15 P	16 S	17 Cl	18 Ar
19 K	20 Ca	21 Sc	22 Ti	23 V	24 Cr	25 Mn	26 Fe	27 Co	28 Ni	29 Cu	30 Zn	31 Ga	32 Ge	33 As	34 Se	35 Br	36 Kr
37 Rb	38 Sr	39 Y	40 Zr	41 Nb	42 Mo	43 Tc	44 Ru	45 Rh	46 Pd	47 Ag	48 Cd	49 In	50 Sn	51 Sb	52 Te	53 I	54 Xe
55 Cs	56 Ba	*	71 Lu	72 Hf	73 Ta	74 W	75 Re	76 Os	5 B	6 C	7 N	8 O	85 At	86 Rn			
87 Fr	88 Ra	**	103 Lr	104 Rf	105 Db	106 Sg	107 Bh	108 Hs	13 Al	14 Si	15 P	16 S	117 Uus	118 Uuo			
lanthanoids	*	57 La	58 Ce	59 Pr	60 Nd	61 Pm	62 Sm		31 Ga	32 Ge	33 As	34 Se					
actinoids	**	89 Ac	90 Th	91 Pa	92 U	93 Np	94 Pu		49 In	50 Sn	51 Sb	52 Te					
									81 Tl	82 Pb	83 Bi	84 Po					

Semiconductors are materials whose electrical properties lie between Conductors and Insulators.

Band theory of conductivity

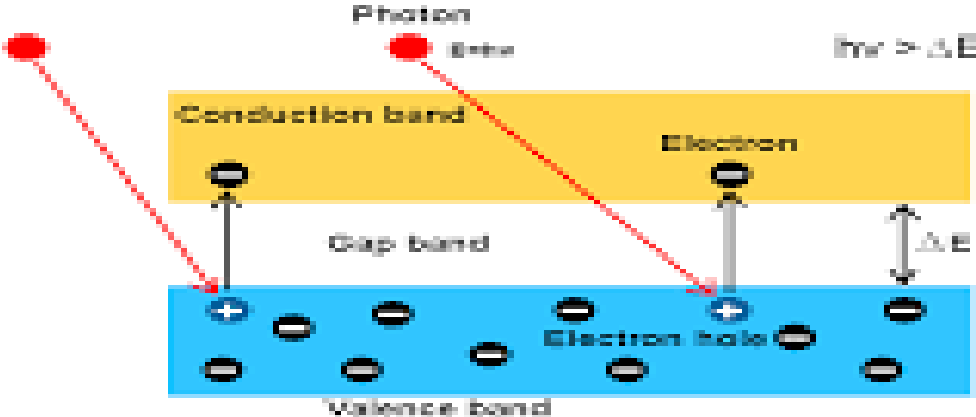
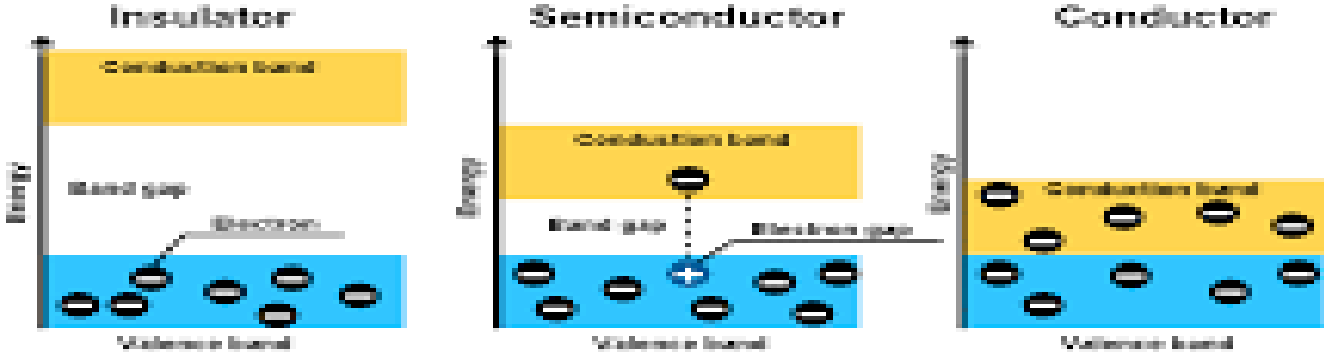

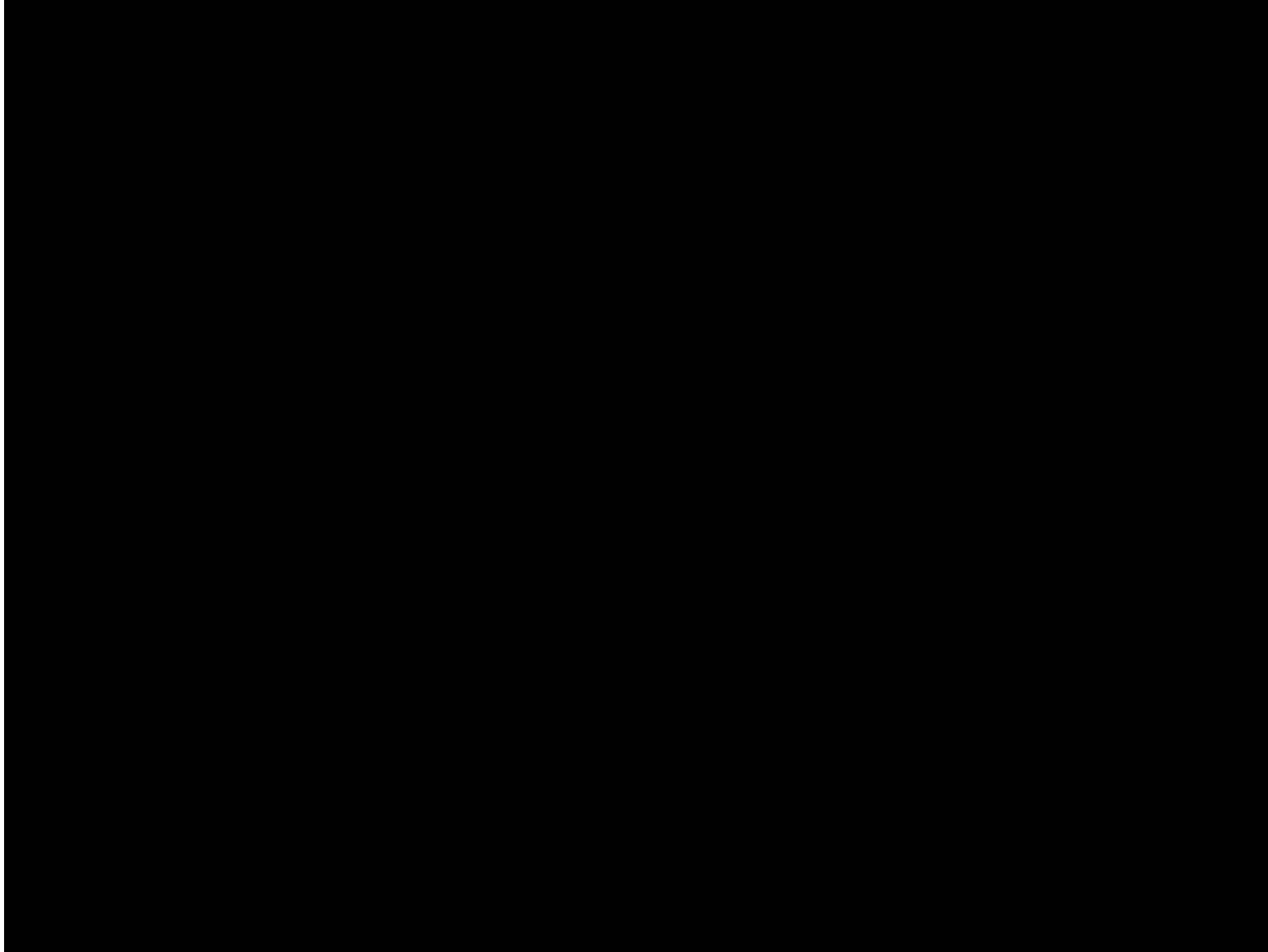

Diamond

- In the diamond structure, the carbon atoms are arranged on an fcc-type lattice with a total of 16 electrons per primitive cell.

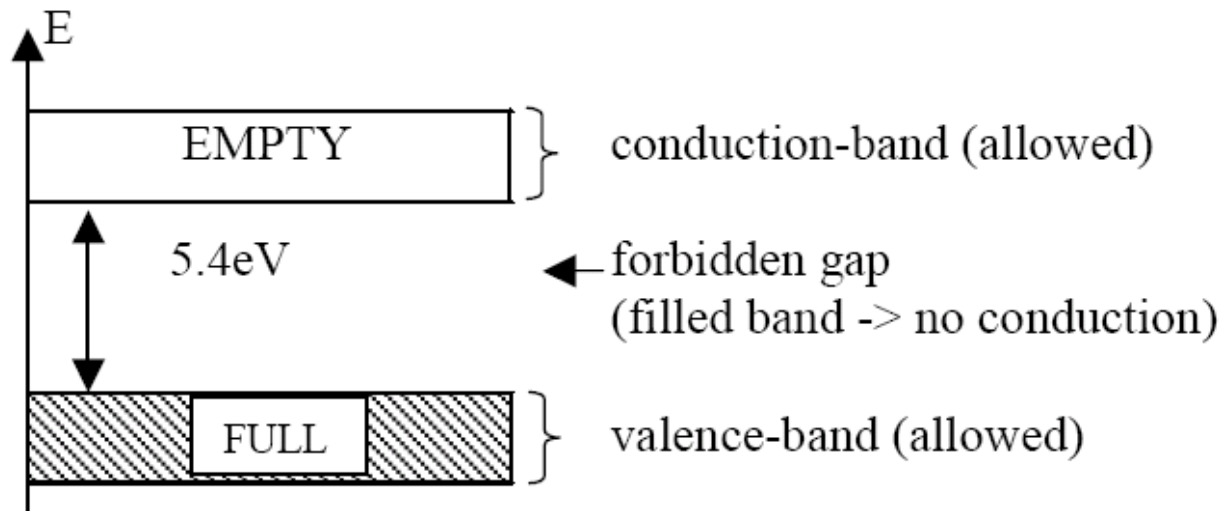
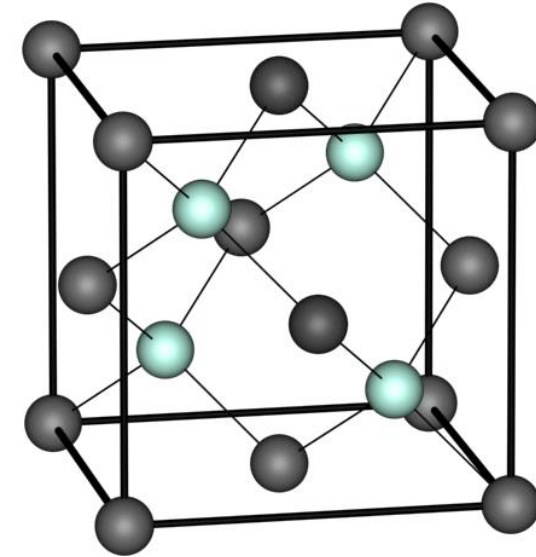

- The valence band and 7 lower bands are full, leaving no electrons in the conduction band.

Silicon

- Silicon has the diamond structure.
- There are 14 electrons per primitive cell.
- Gap is only 1.12 eV, however.

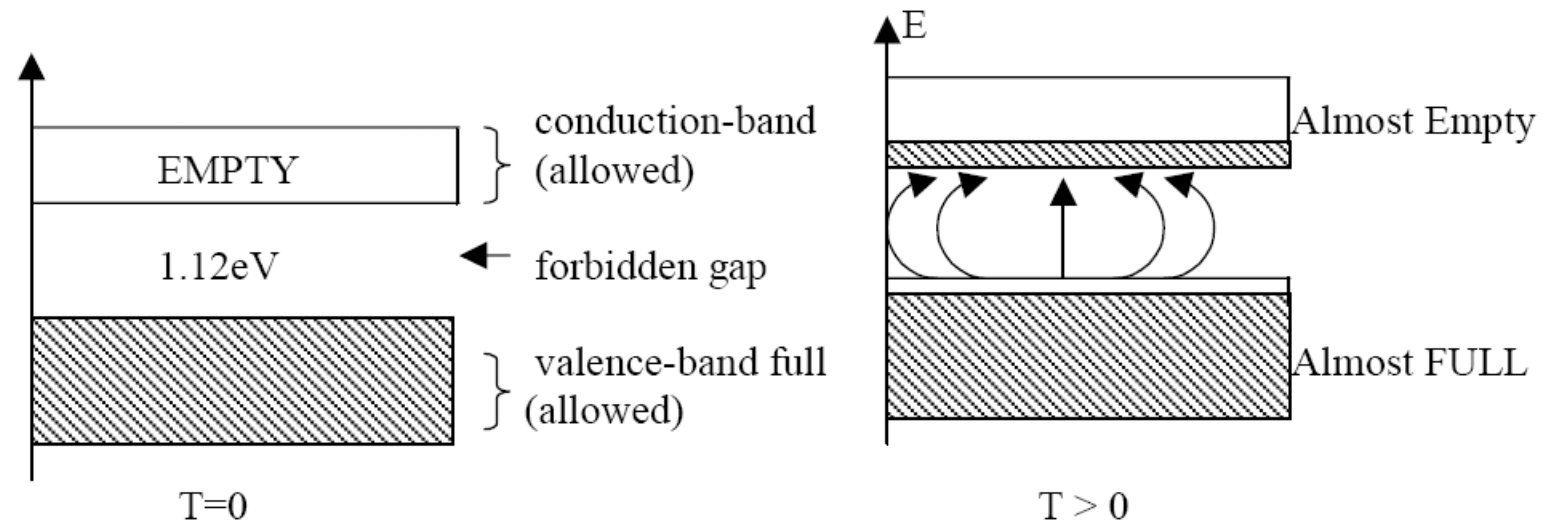
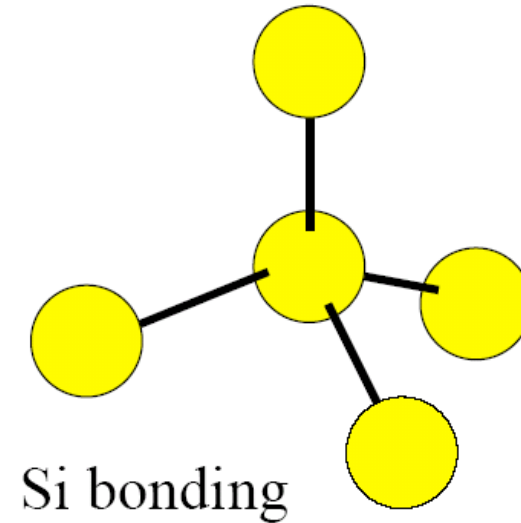

Now there is a small (but finite) chance for a few electrons to be thermally excited from valence band to conduction band.

What are P-type and N-type ?

- Semiconductors are classified in to P-type and N-type semiconductor
- P-type: A P-type material is one in which holes are majority carriers i.e. they are positively charged materials (++++)
- N-type: A N-type material is one in which electrons are majority charge carriers i.e. they are negatively charged materials (-----)

Intrinsic Semiconductors

A perfect semiconductor crystal containing no impurities or lattice defects is called an intrinsic semiconductor. As the carriers are generated in pairs, the concentration n of electrons in the conduction band equals the concentration p of holes in the valence band,

Extrinsic Semiconductors

- Extrinsic semiconductors: we can add impurities to make a material semiconducting (or to change the properties of the gap).
- There are 2 types of extrinsic semiconductors:
 p-type and n-type
- These are materials which have mostly hole carriers (p) or electron carriers (n).
- These give you ways of modifying the band gap energies (important for electronics, detectors, etc).

Extrinsic Semiconductors: *n* type

- Add a small amount of phosphorus (P: $3s^23p^3$) to Silicon (Si: $3s^23p^2$) (generally, a group V element to a group IV host) P replaces a Si atom and it donates an electron to the conduction band (P is called the donor atom). The periodic potential is disrupted and we get a localized energy level, ϵ_D .

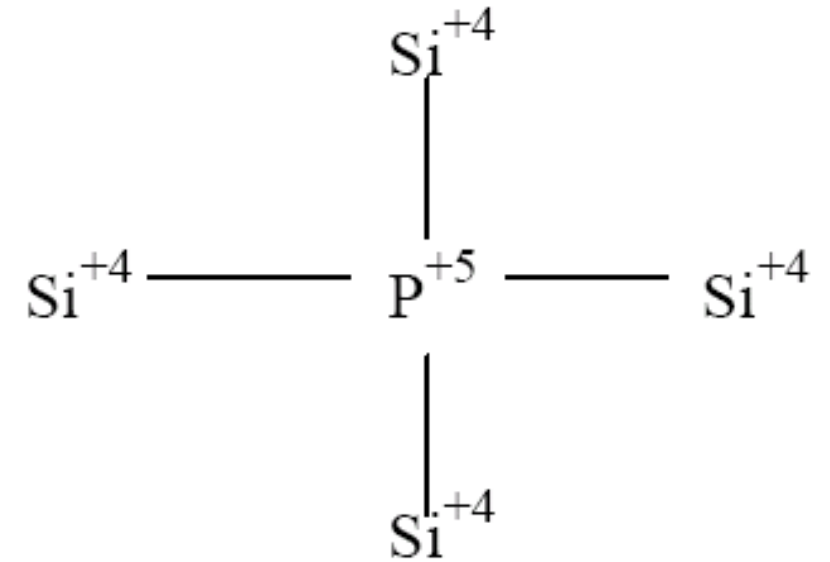

- This is an n-type semiconductor – more electrons around that can be mobile; and the Fermi energy is closer to the conduction band.

Extrinsic Semiconductors: *n* type

Phosphorus provides an extra electron.

$$\varepsilon_C - \varepsilon_D = 45 \text{ meV}$$

So, it's easy for the donor electrons to enter the conduction band at room temperature.

This means that at room temperature $n \approx N_D$.

This is called complete ionization (only true if $n_i \ll N_D$). Therefore, by doping Si crystal with phosphorus, we increase the free electron concentration.

At low temperature, these extra electrons get trapped at the donor sites (no longer very mobile) - the dopant is frozen out.

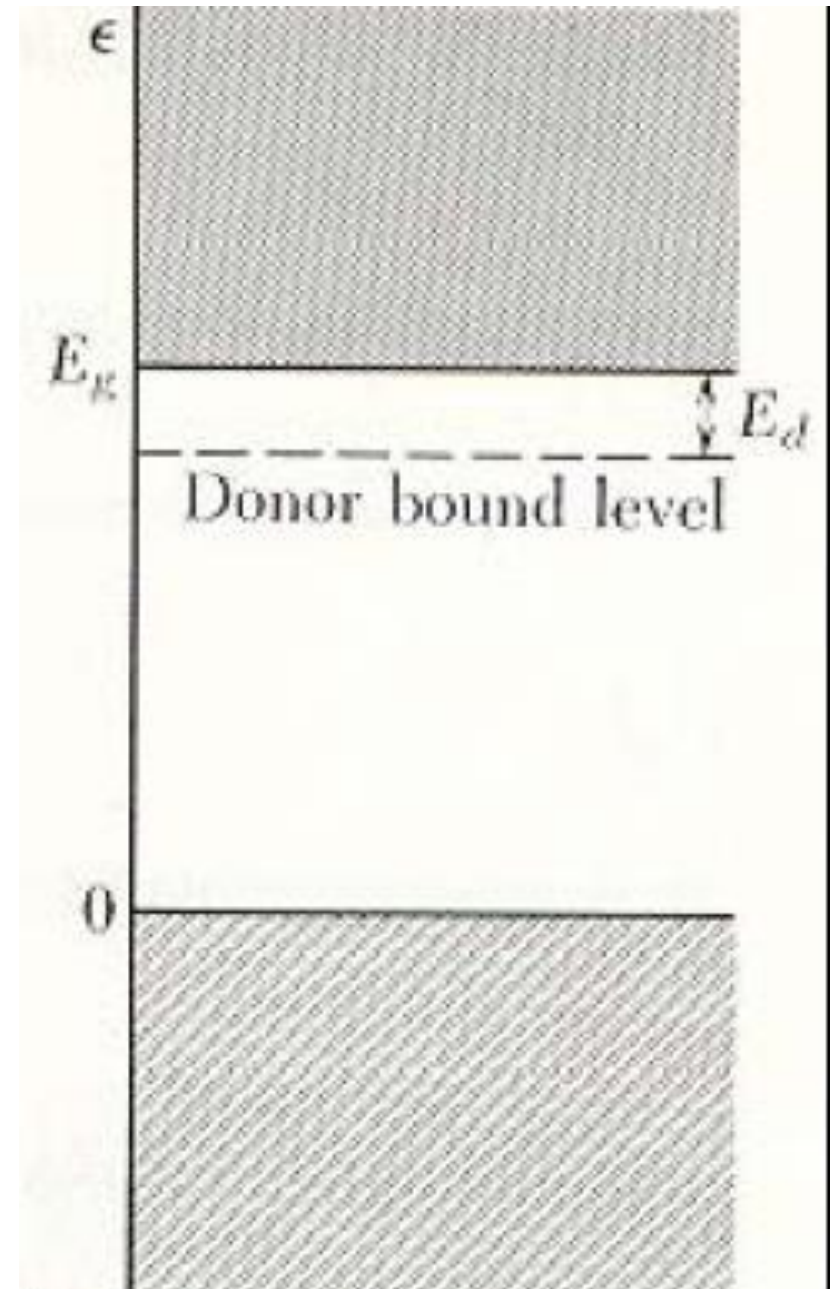

Extrinsic Semiconductors: p type

- Next suppose Si atom is replaced with Boron (B: $2s^22p$) to Silicon (Si: $3s^23p^2$). Again, we have a perturbed lattice and a localized E-level created.
- Boron is missing an electron and accepts an electron from valence band, creating a hole.
- Therefore doping with B increases hole concentration. We call this p -type doping, the electron concentration n is reduced.
- ϵ_F moves closer to ϵ_V .

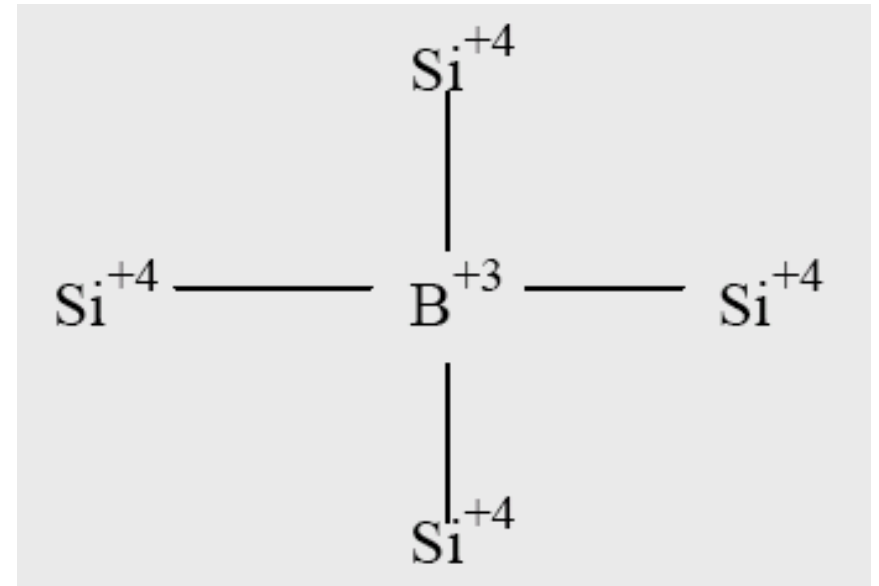

Semiconductors

intrinsic semiconductor

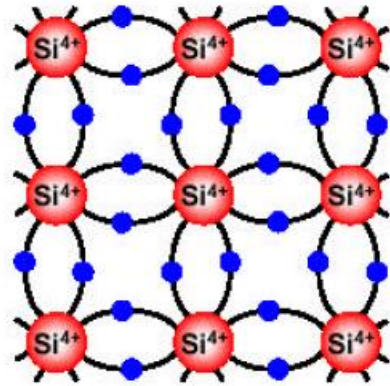

$$n = p = n_i$$

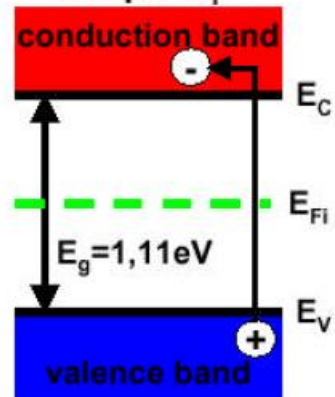

extrinsic n-type (donor-doped)

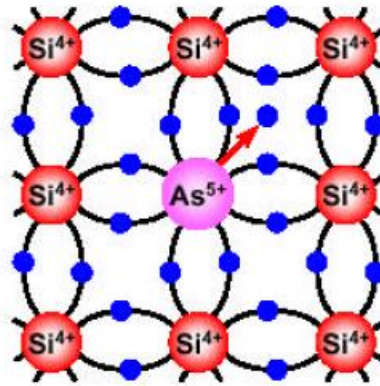

$$n \gg p$$

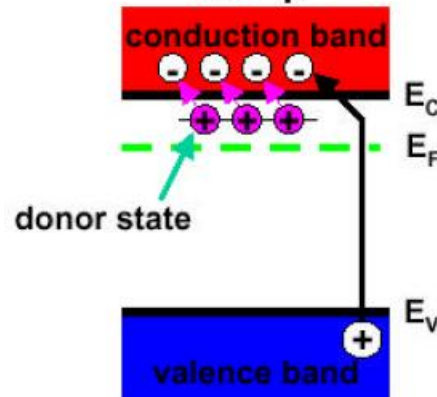

extrinsic p-type (acceptor-doped)

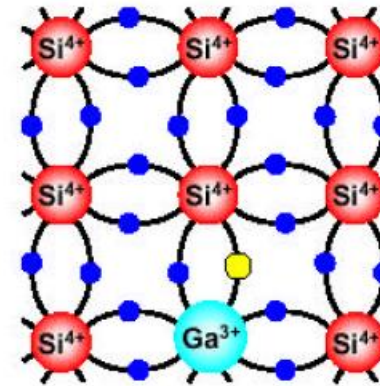

$$n \ll p$$

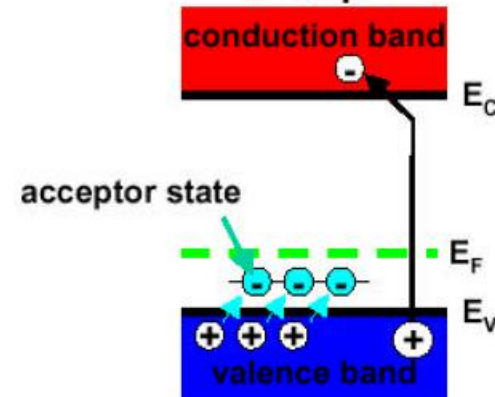

Diodes

Electronic devices created by bringing together a p -type and n -type region within the same semiconductor lattice. Used for rectifiers, LED etc.

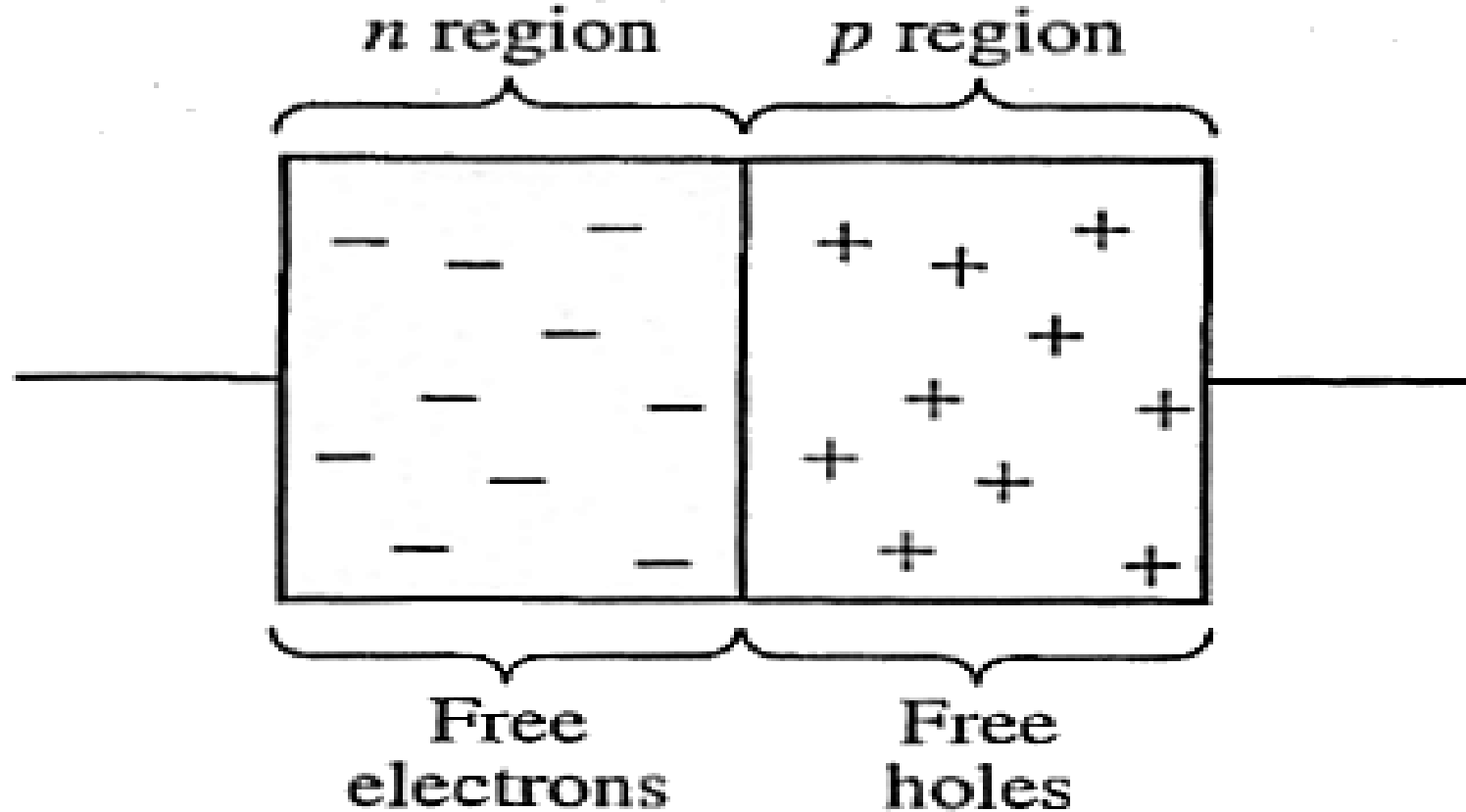

Forward Bias and Reverse Bias

- Forward Bias : Connect positive of the Diode to positive of supply...negative of Diode to negative of supply
- Reverse Bias: Connect positive of the Diode to negative of supply...negative of diode to positive of supply.

FORWARD BIAS

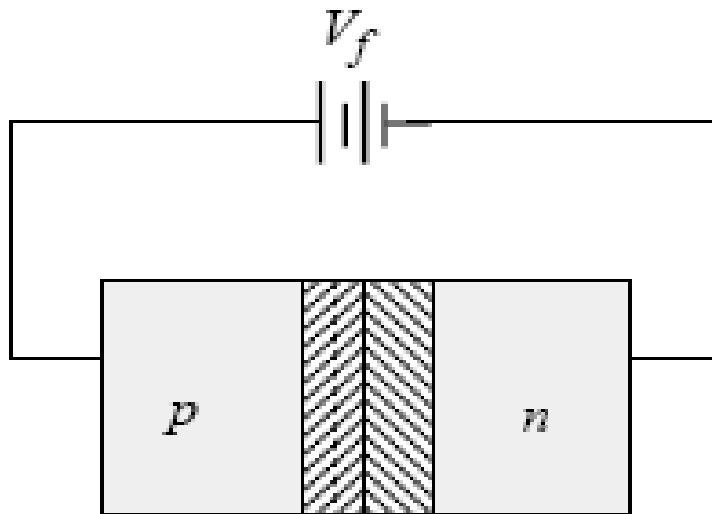

REVERSE BIAS

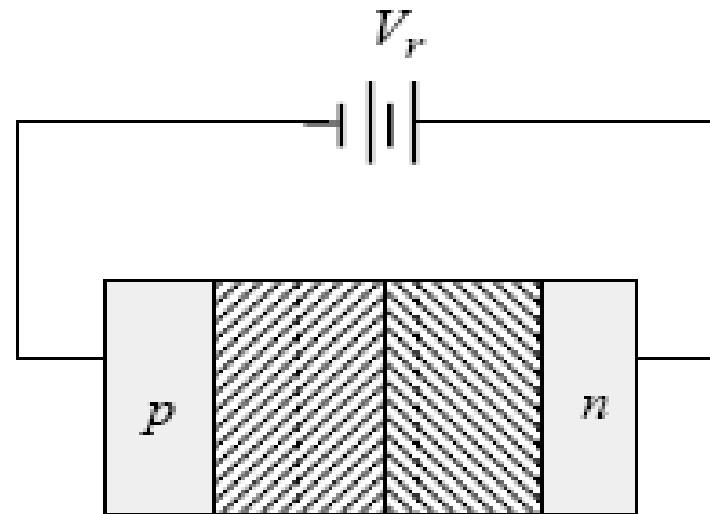

Characteristics of Diode

- Diode always conducts in one direction.
- Diodes always conduct current when “Forward Biased” (Zero resistance)
- Diodes do not conduct when Reverse Biased (Infinite resistance)

I-V characteristics of Ideal diode

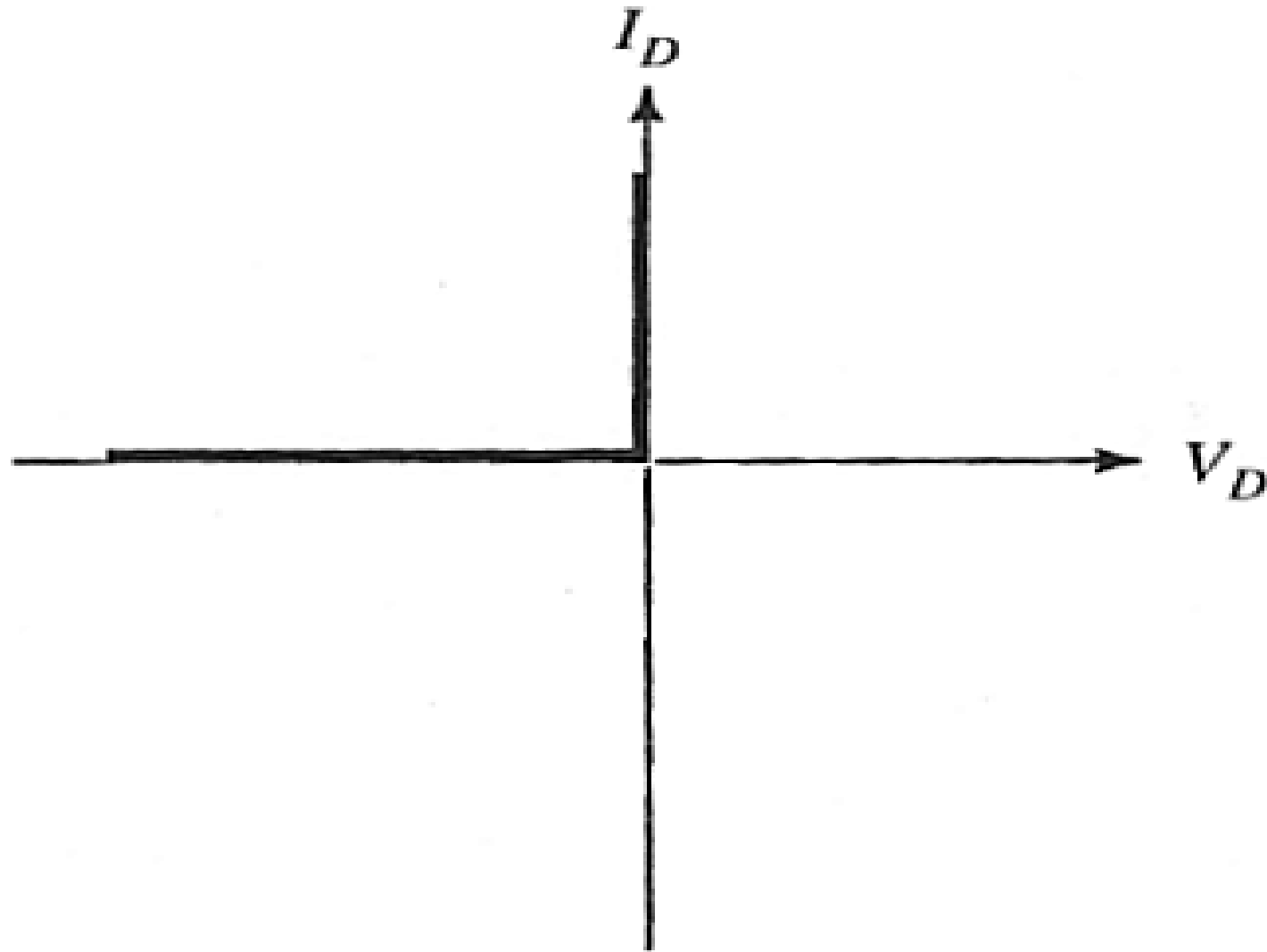

I-V Characteristics of Practical Diode

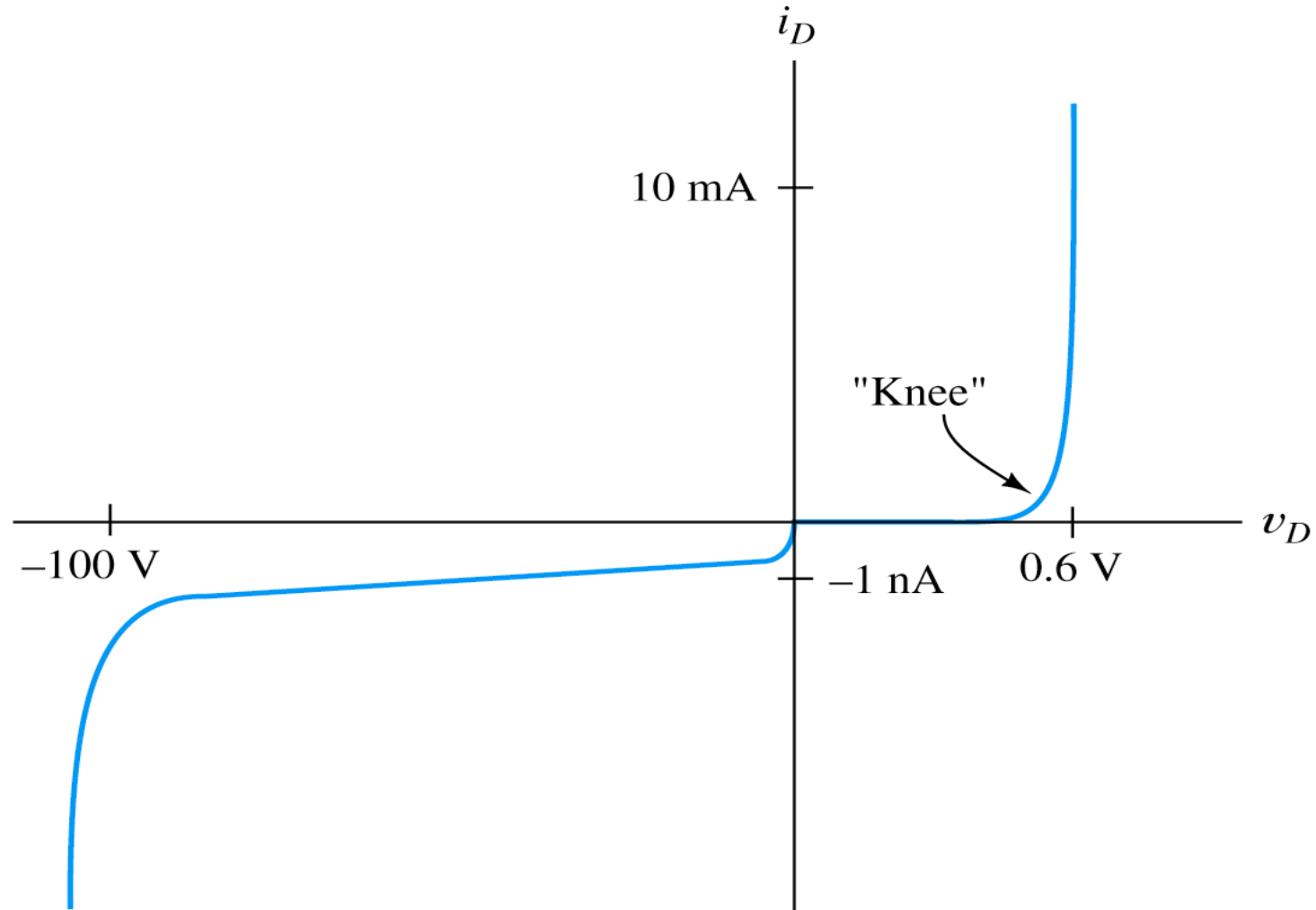

Volt-ampere characteristic for a typical small-signal silicon diode at a temperature of 300 K. Notice the change of scale for negative current and voltage.

Electrons & Holes

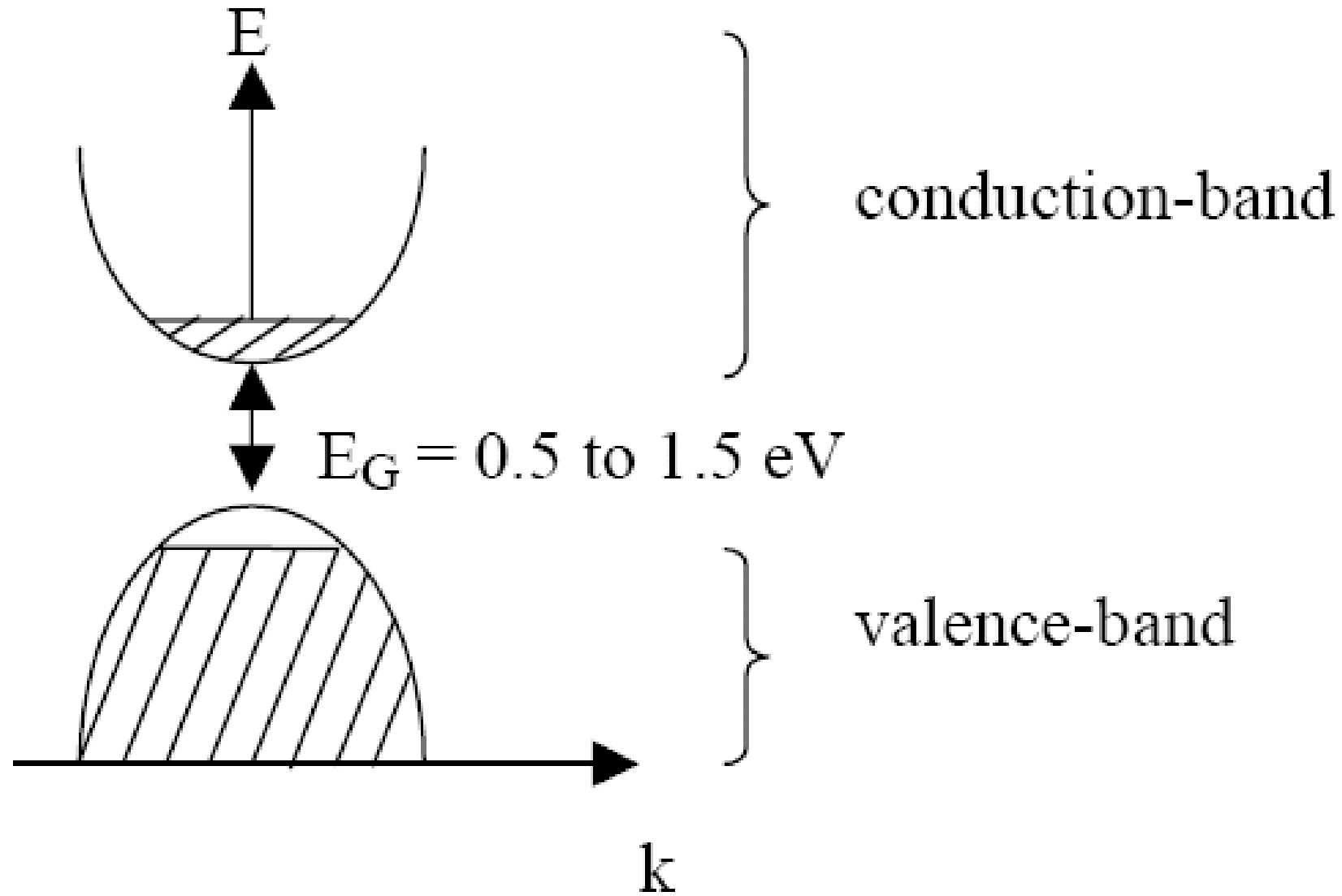



Solar cell: Solar cell is a photovoltaic device that converts the light energy into electrical energy based on the principles of photovoltaic effect

Albert Einstein was awarded the 1921 Nobel Prize in physics for his research on the photoelectric effect—a phenomenon central to the generation of electricity through solar cells.

In the early stages, the solar cell was developed only with 4 to 6 % efficiency (because of inadequate materials and problems in focusing the solar radiations). But, after 1989, the solar cells with more than 50% efficiency was developed.

Electrons & Holes

For the electrons occupying the vacant states,

$$\left(\frac{1}{\hbar^2} \frac{d^2 \varepsilon}{dk^2} \right) < 0$$

(Negative!) and the electrons will move in same direction as electric field (wrong way!)

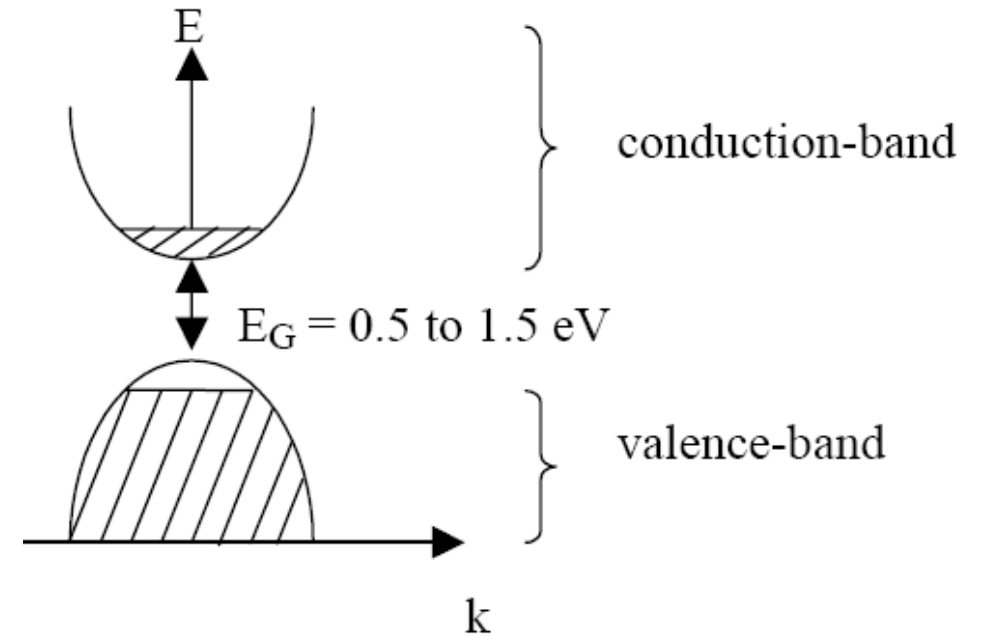

In a semiconductor, there are two charge carriers:

- **Electrons** (conduction band)
 - negative mass
 - negative charge
- **Holes** (valence band)
 - positive mass,
 - positive charge

Three generations of solar cells

First Generation

First generation cells consist of large-area, high quality and single junction devices.

First Generation technologies involve high energy and labour inputs which prevent any significant progress in reducing production costs.

First generation

Mono-crystalline Silicon Cells: Mono-crystalline cells are made from a single large crystal wafer of silicon. These cells have high efficiency

S.No	Advantages	Disadvantages
1	Broad spectral absorption range	Requires expensive manufacturing technologies
2	High carrier mobilities	Growing First generation solar cell is a highly energy intensive process
3		Energy wasted as heat for higher energy photons

Second generation

Poly-crystalline Silicon Cells: They are made of silicon wafers cut from squares of silicon. They show greater stability under electric field and light-induced stress

Amorphous Silicon Cells: non-crystalline form of silicon. They are built using two or three junctions to increase solar spectrum which can be utilized. Used in calculators.

Cadmium-Telluride Cells: The crystalline compound cadmium-telluride (CdTe) is an effective solar cell material – it is a very strong absorber of light and has a band gap almost perfectly tuned to match the solar spectrum. Inexpensive production methods.

Copper-Indium/Gallium-DiSelenide Cells: made from a combination of copper-indium-diselenide and copper-gallium-diselenide (CIGS cells). The mixture of the two materials creates a more complex and effective heterojunction

Second generation

S.N ○	Advantages	Disadvantages
1	Lower manufacturing cost	The efficiencies of thin-film solar cells are lower compared with silicon (wafer-based) solar cells.
2	Reduced mass	Amorphous silicon is not stable
3	Allows fitting panels on light or flexible materials, even textiles	Increased toxicity

Second Generation

Second generation materials have been developed to address energy requirements and production costs of solar cells.

Alternative manufacturing techniques such as vapour deposition and electroplating are advantageous as they reduce high temperature processing significantly

Materials for Solar cell

Solar cells are composed of various semiconducting materials

1. Crystalline silicon
2. Cadmium telluride
3. Copper indium diselenide
4. Gallium arsenide
5. Indium phosphide
6. Zinc sulphide

Note: Semiconductors are materials, which become electrically conductive when supplied with light or heat, but which operate as insulators at low temperatures

- Over 95% of all the *solar cells produced* worldwide are composed of the semiconductor material *Silicon (Si)*. As the second most abundant element in earth's crust, silicon has the advantage, of being available in sufficient quantities.
- To produce a solar cell, the semiconductor is contaminated or "*doped*".
- "Doping" is the intentional introduction of *chemical elements* into the semiconductor.
- By doing this, depending upon the type of dopant, one can obtain a surplus of either positive charge carriers (called *p-conducting semiconductor layer*) or negative charge carriers (called *n-conducting semiconductor layer*).

2. Photovoltaic effect

Definition:

The generation of voltage across the PN junction in a semiconductor due to the absorption of light radiation is called photovoltaic effect. The Devices based on this effect is called photovoltaic device.

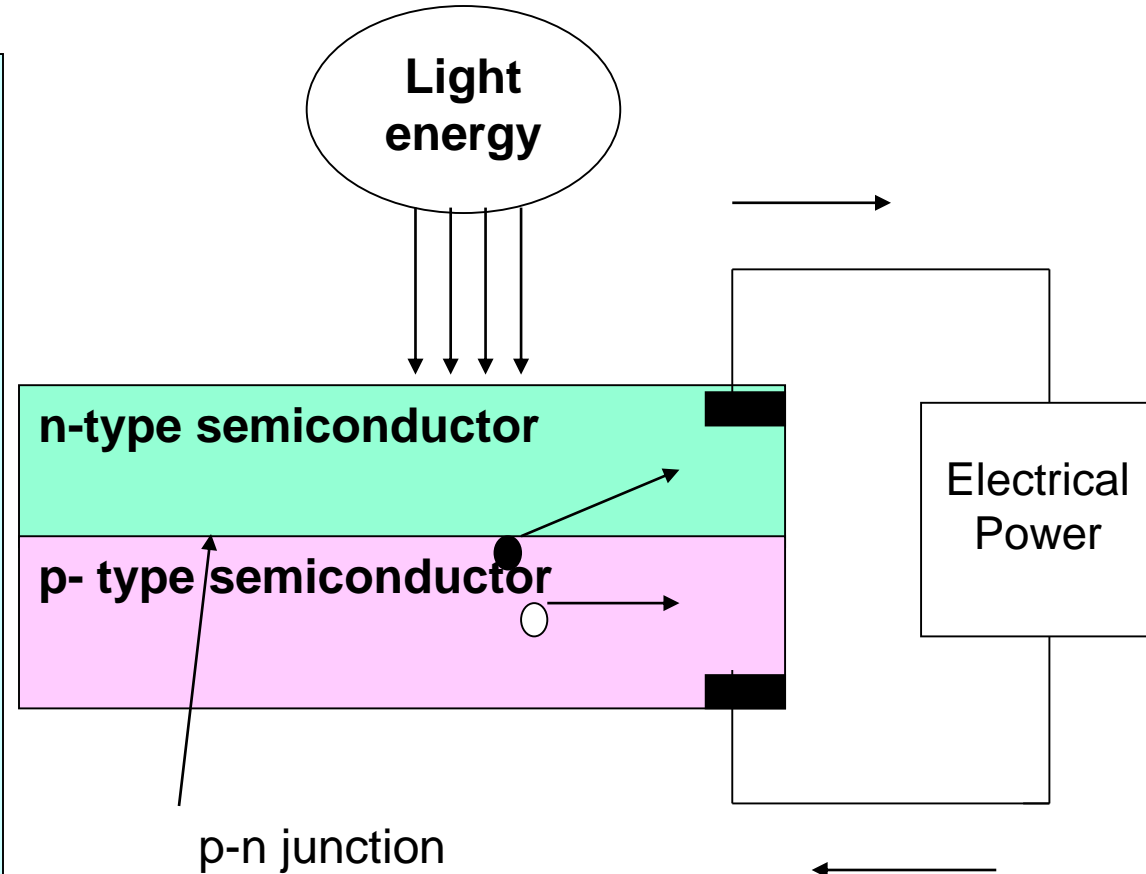

3. electron-hole formation

- Photovoltaic energy conversion relies on the number of *photons strikes on the earth*. (photon is a flux of light particles)
- On a clear day, about 4.4×10^{17} *photons* strike a square centimeter of the Earth's surface every second.
- Only some of these photons - those with *energy in excess of the band gap* - can be converted into electricity by the solar cell.
- When such photon enters the semiconductor, it may be absorbed and *promote an electron* from the valence band to the conduction band.

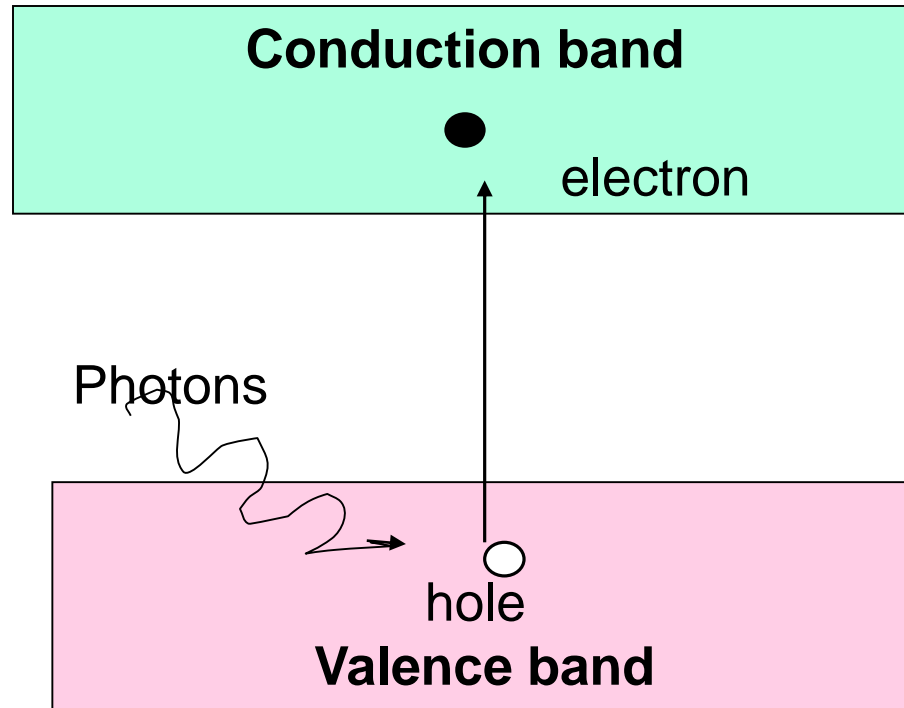

- Therefore, a *vacant is created* in the valence band and it is called hole.
- Now, the electron in the conduction band and hole in valence band *combine together* and forms *electron-hole pairs*.

4. A solar panel (or) Solar array

Single solar cell

- The single solar cell constitute the *n-type* layer *sandwiched* with *p-type* layer.
- The most *commonly* known *solar cell* is configured as a large-area p-n junction made from *silicon wafer*.
- A *single cell* can produce only very *tiny* amounts of *electricity*
- It can be used only to light up a small light bulb or power a calculator.
- Single photovoltaic cells are used in many small electronic appliances such as watches and calculators

Solar panel (or) solar array (or) Solar module

The solar panel (or) solar array is the interconnection of number of solar module to get efficient power.

- A solar module consists of number of interconnected solar cells.
- These interconnected cells embedded between two glass plate to protect from the bad weather.
- Since absorption area of module is high, more energy can be produced.

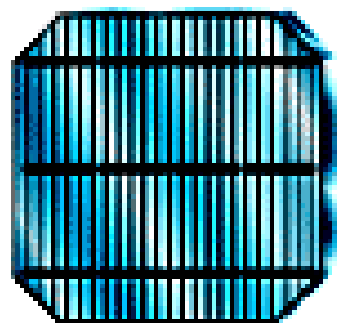

Cell

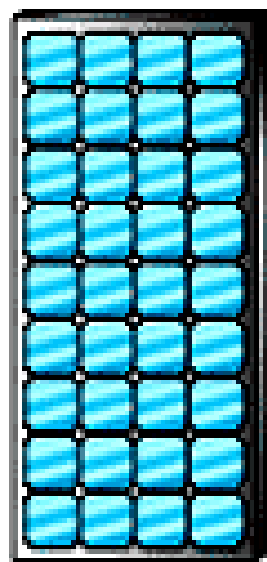

Module

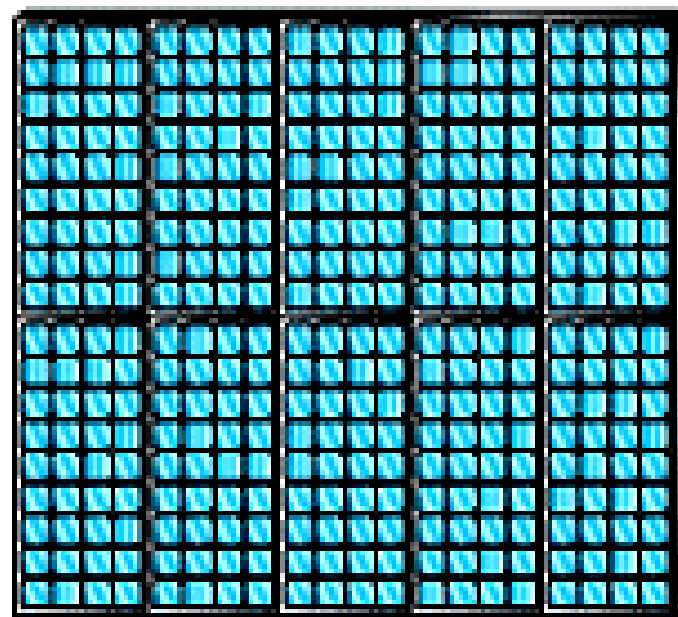

Array

5. Types of Solar cell

Based on the types of crystal used, solar cells can be classified as,

1. Monocrystalline silicon cells
2. Polycrystalline silicon cells
3. Amorphous silicon cells

1. The Monocrystalline silicon cell is produced from *pure silicon (single crystal)*. Since the Monocrystalline silicon is pure and defect free, the efficiency of cell will be higher.
2. In polycrystalline solar cell, *liquid silicon* is used as raw material and polycrystalline silicon was obtained followed by *solidification process*. The materials contain various crystalline sizes. Hence, the efficiency of this type of cell is less than Monocrystalline cell.

3. Amorphous silicon was obtained by *depositing silicon film on the substrate like glass plate.*

- The layer thickness amounts to less than $1\mu\text{m}$ – the thickness of a human hair for comparison is $50\text{-}100\mu\text{m}$.
- The efficiency of amorphous cells is much lower than that of the other two cell types.
- As a result, they are used mainly in low power equipment, such as watches and pocket calculators, or as facade elements.

Comparison of Types of solar cell

Material	Efficiency (%)
Monocrystalline silicon	14-17
Polycrystalline silicon	13-15
Amorphous silicon	5-7

6. Principle, construction and working of Solar cell

Principle: The solar cells are based on the principles of photovoltaic effect. The **photovoltaic effect** is the photogeneration of charge carriers in a light absorbing materials as a result of absorption of light radiation.

Construction

- Solar cell (crystalline Silicon) consists of a ***n-type semiconductor (emitter)*** layer and ***p-type semiconductor layer (base)***. The two layers are sandwiched and hence there is formation of p-n ***junction***.
- The surface is coated with ***anti-reflection coating*** to avoid the loss of incident light energy due to reflection.

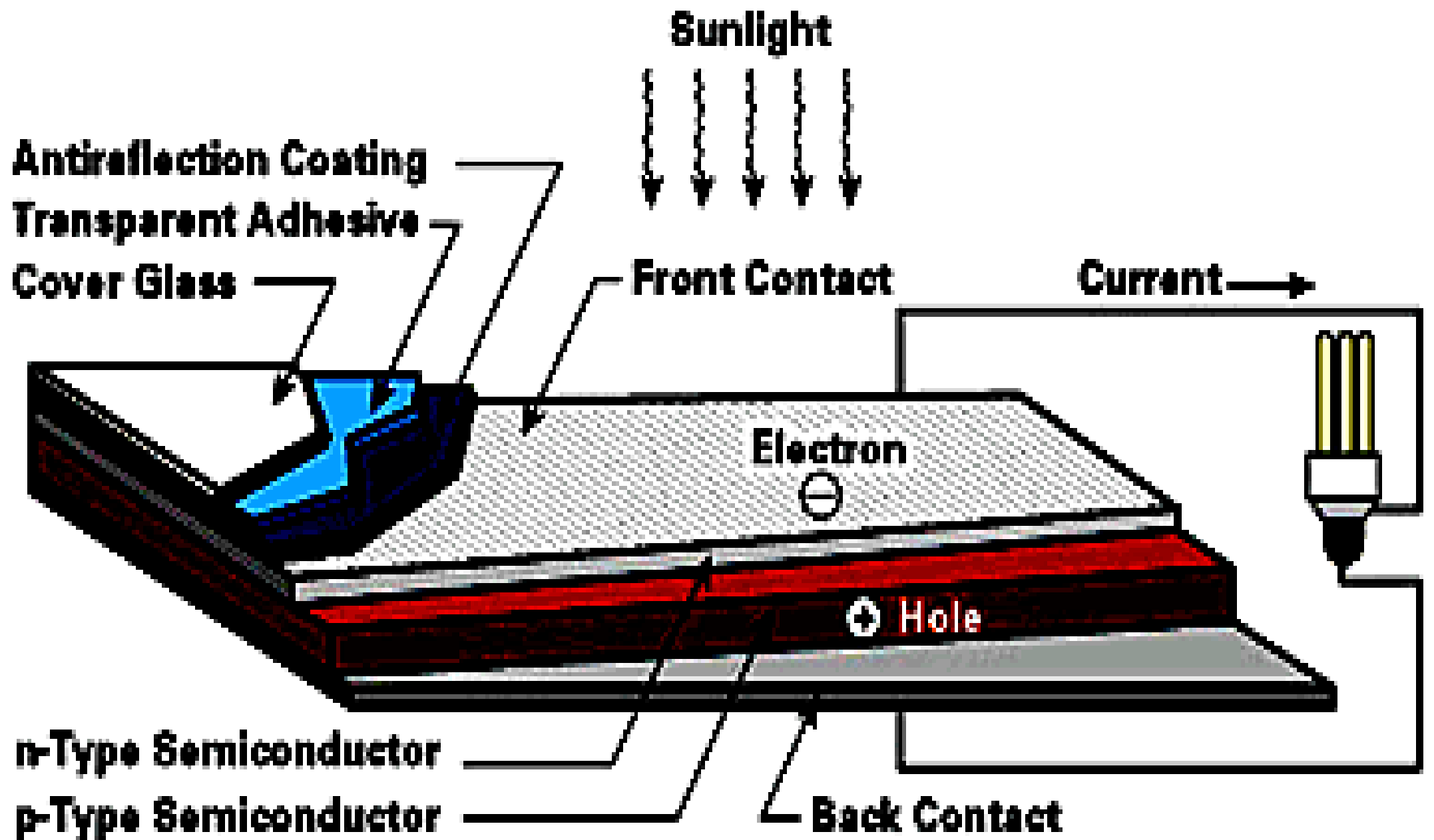

How Solar Cells Work

©2006 HowStuffWorks

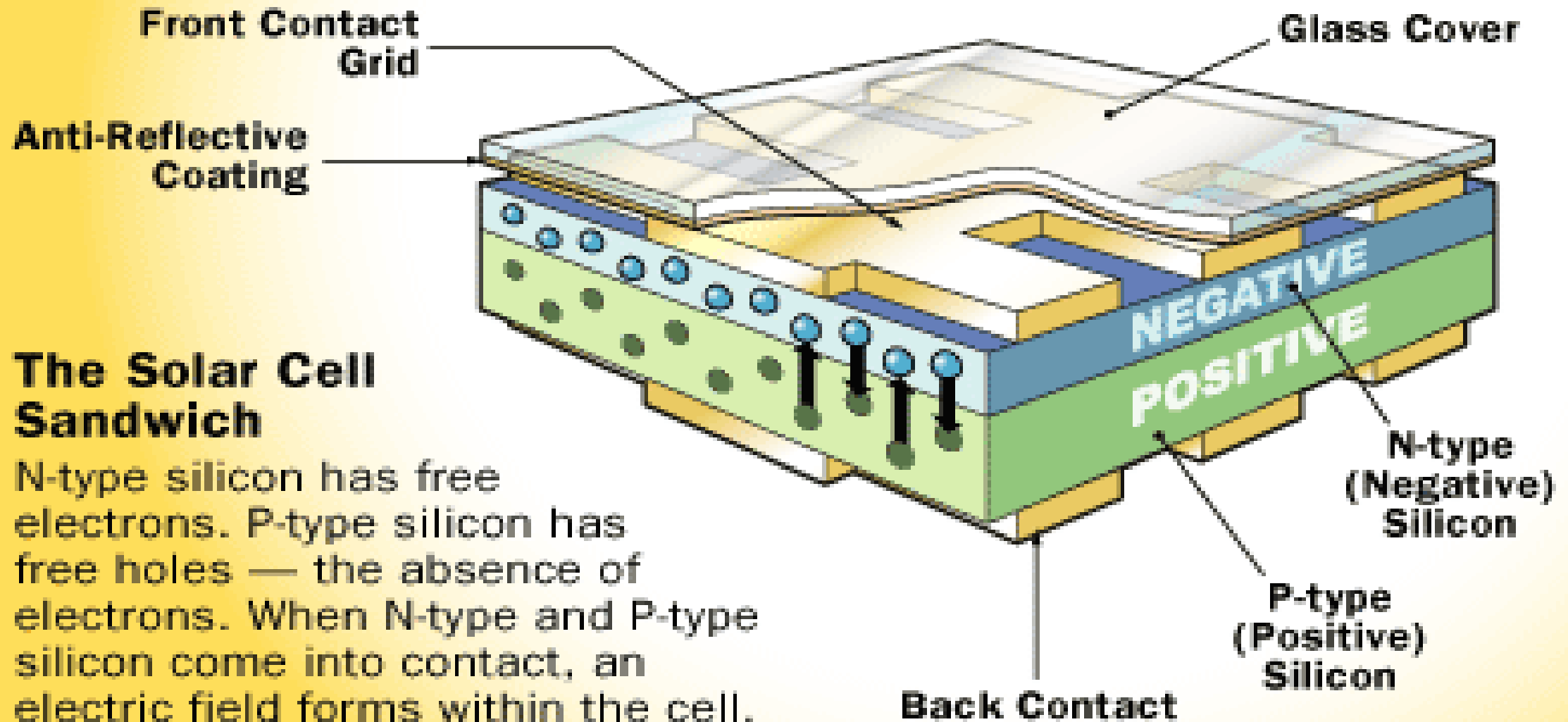

- A proper *metal contacts* are made on the n-type and p-type side of the semiconductor for electrical connection

Working:

- When a solar *panel exposed to sunlight*, the light energies are absorbed by a semiconduction materials.
- Due to this absorded enrgy, the electrons are libereted and produce the external DC current.
- The DC current is converted into 240-volt AC current using an inverter for different applications.

Mechanism:

- First, the *sunlight is absorbed* by a solar cell in a solar panel.
- The absorbed light causes *electrons* in the material to *increase in energy*. At the same time making them free to move around in the material.
- However, the electrons *remain* at this *higher energy* for only a *short time* before returning to their original lower energy position.
- Therefore, to *collect the carriers* before they lose the energy gained from the light, a *PN junction* is typically *used*.

- A PN junction consists of two different regions of a semiconductor material (usually silicon), with one side called the p type region and the other the n-type region.
- During the incident of light energy, in p-type material, *electrons* can gain energy and *move* into the *n-type region*.
- Then they can *no* longer go *back* to their original *low energy* position and remain at a higher energy.
- The process of moving a light- generated carrier from p-type region to n-type region is called *collection*.
- These *collections of carriers* (electrons) can be either *extracted* from the device to *give a current*, or it can remain in the device and gives rise to a voltage.

- The *electrons* that leave the solar cell as current give up their energy to whatever is connected to the solar cell, and then *re-enter the solar cell*. Once back in the solar cell, the process begins again:

The mechanism of electricity production- Different stages

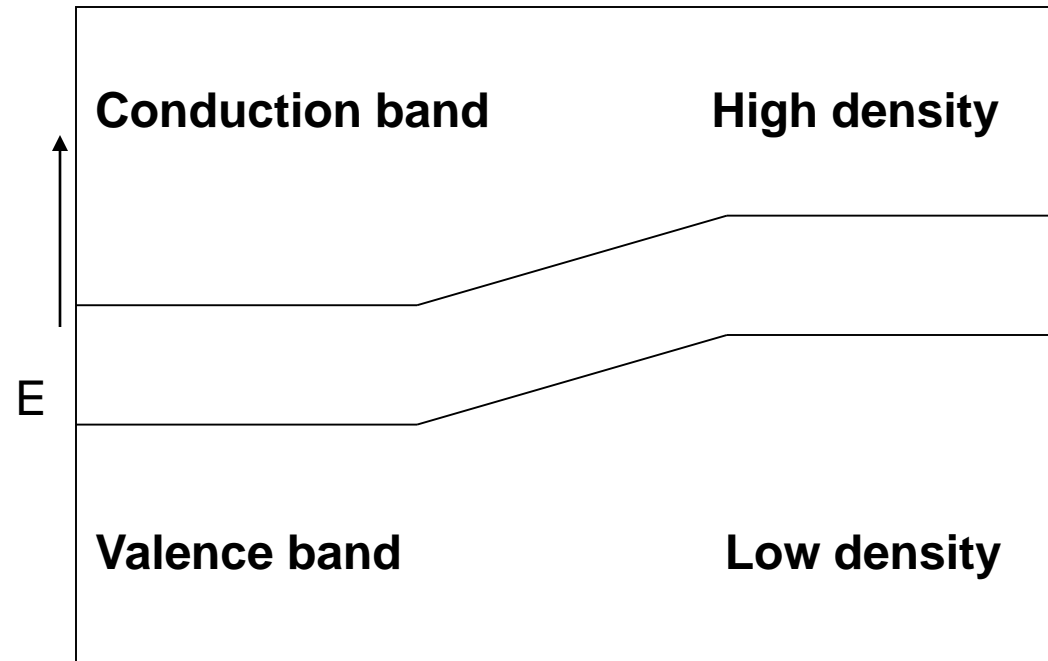

The above diagram shows the formation of p-n junction in a solar cell. The valence band is a low-density band and conduction band is high-density band.

Stage-1

When light falls on the semiconductor surface, the electron from valence band promoted to conduction band.

Therefore, the hole (vacancy position left by the electron in the valence band) is generated. Hence, there is a formation of electron-hole pair on the sides of p-n junction.

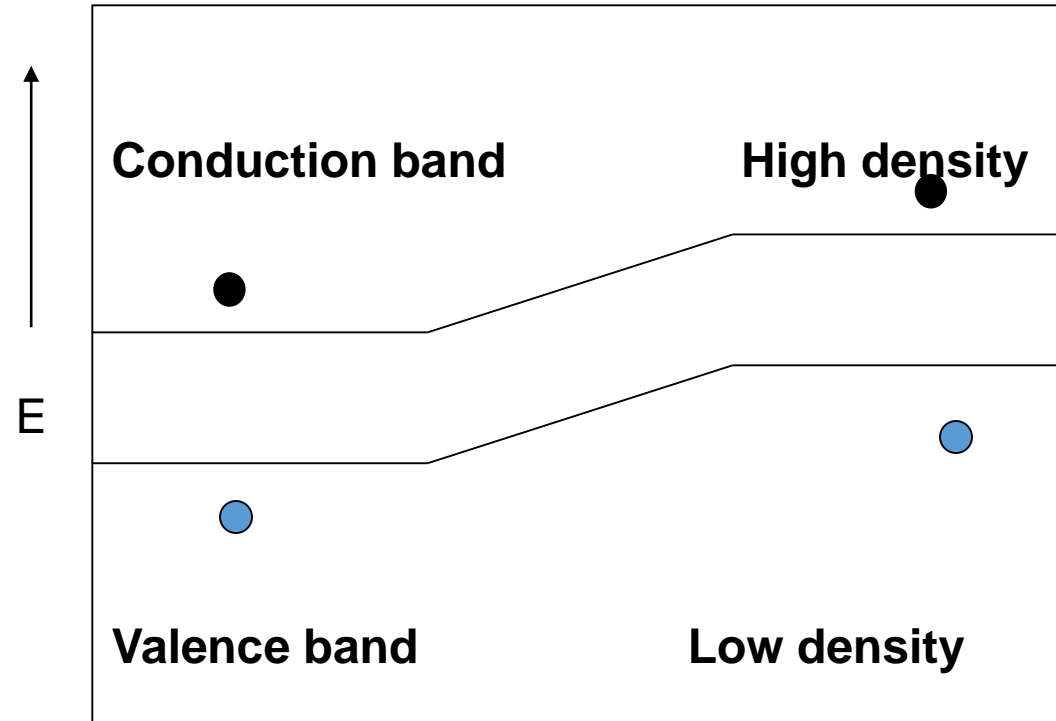

Stage-2

In the stage 2, the electron and holes are diffuse across the p-n junction and there is a formation of electron-hole pair.

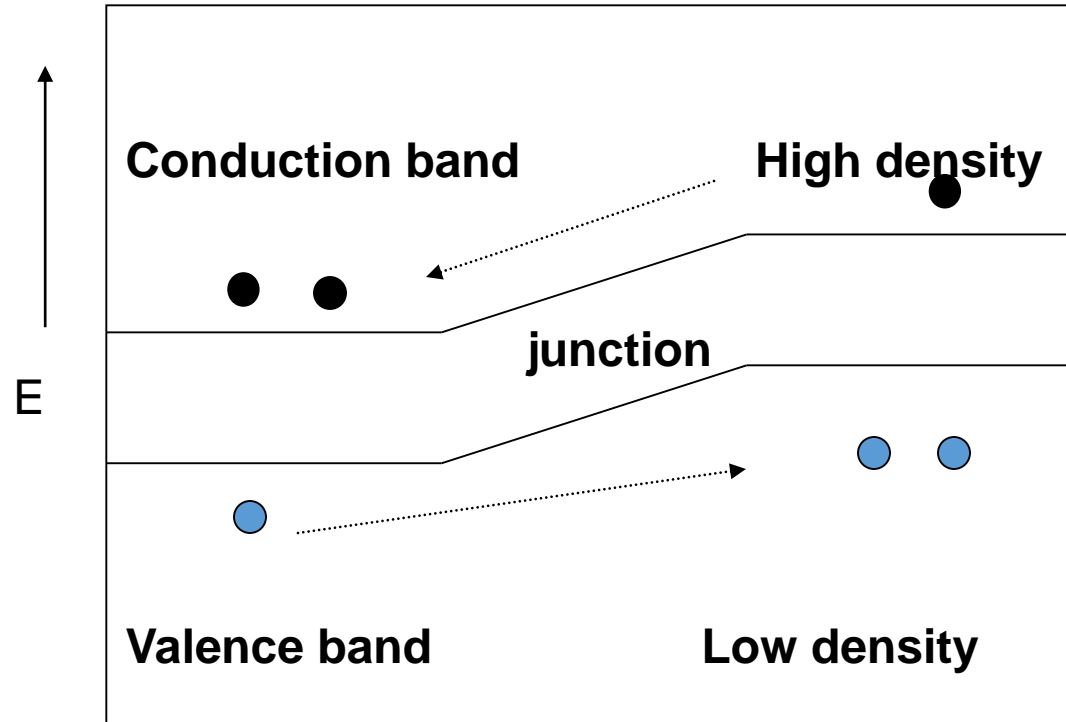

Stage-3

In the stage 3, As electron continuous to diffuse, the negative charge build on emitter side and positive charge build on the base side.

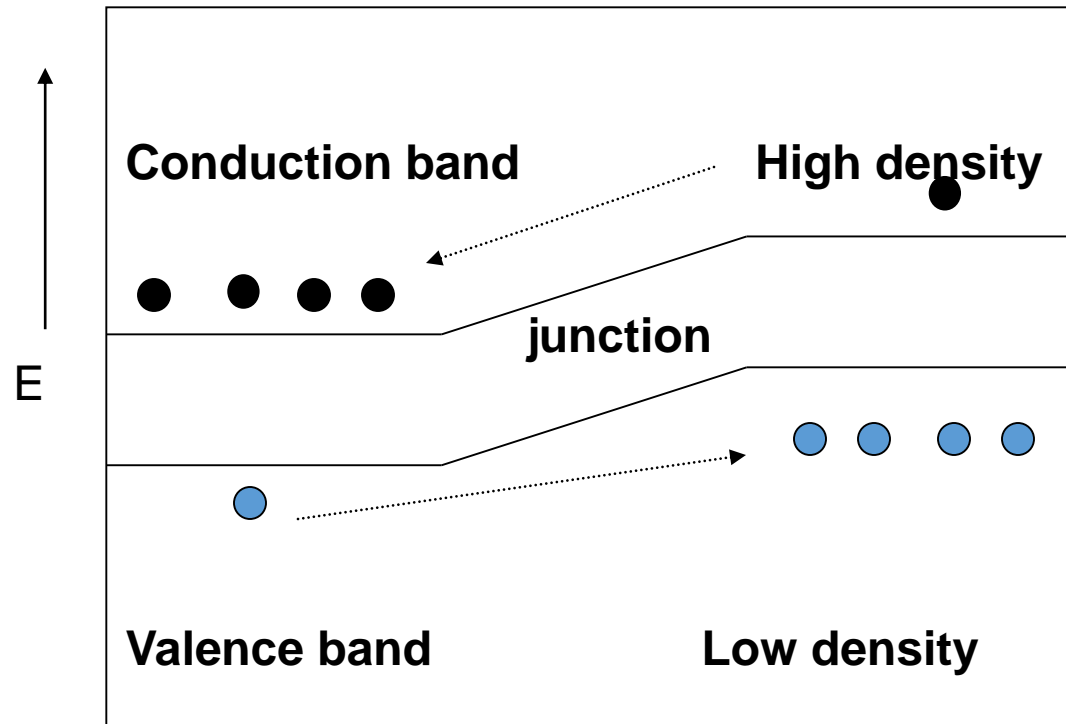

Stage-4

When the PN junction is connected with external circuit, the current flows.

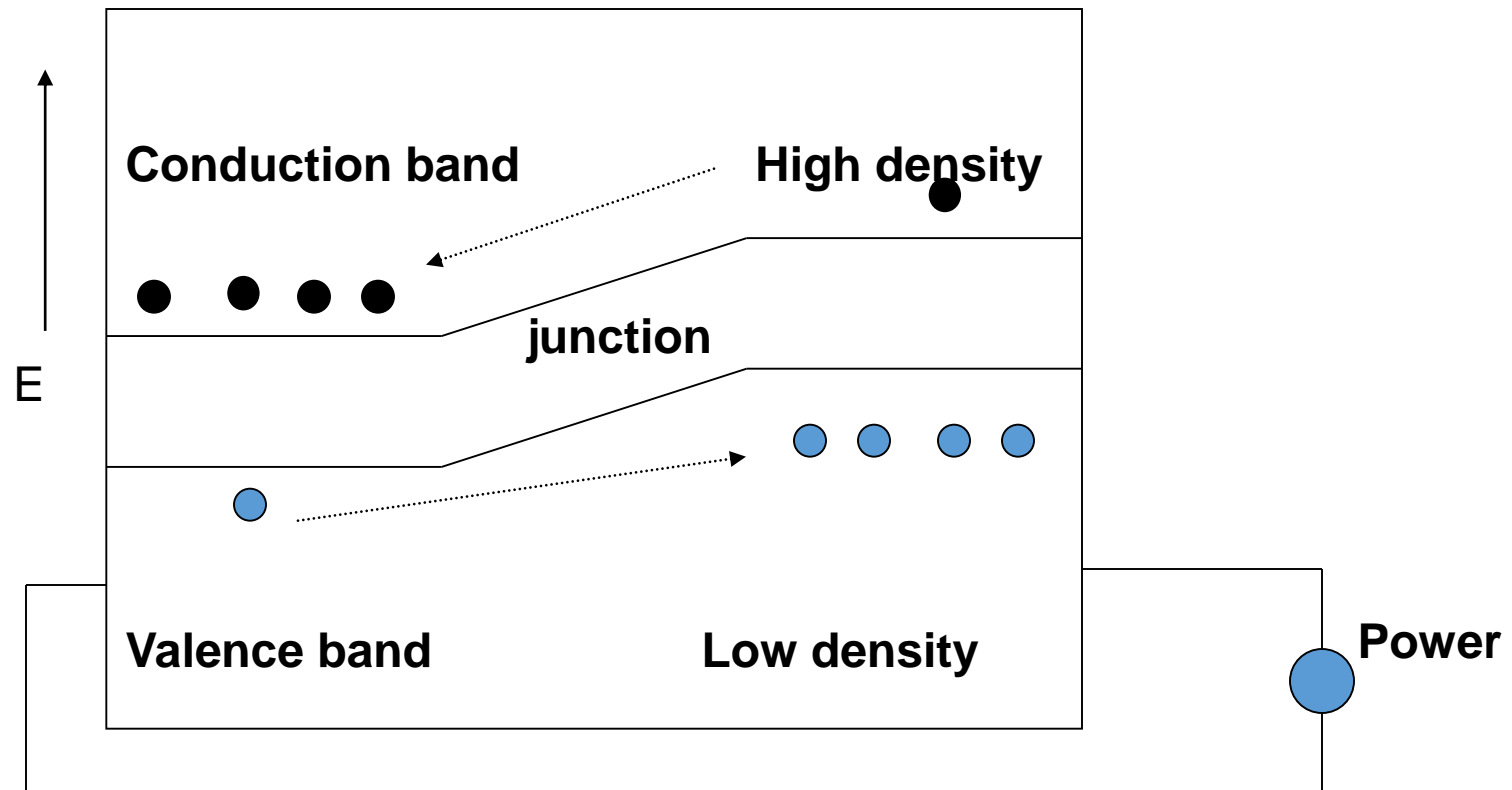

7. Advantage, disadvantage and application of Solar cell

Advantage

1. It is clean and non-polluting
2. It is a renewable energy
3. Solar cells do not produce noise and they are totally silent.
4. They require very little maintenance
5. They are long lasting sources of energy which can be used almost anywhere
6. They have long life time
7. There are no fuel costs or fuel supply problems

Disadvantage

1. Solar power can be obtained in night time
2. Solar cells (or) solar panels are very expensive
3. Energy has not be stored in batteries
4. Air pollution and whether can affect the production of electricity
5. They need large are of land to produce more efficient power supply

Applications

1. Soar pumps are used for water supply.

1. Domestic power supply for appliances include refrigeration, washing machine, television and lighting

1. Ocean navigation aids: Number of lighthouses and most buoys are powered by solar cells

1. Telecommunication systems: radio transceivers on mountain tops, or telephone boxes in the country can often be solar powered

1. Electric power generation in space: To providing electrical power to satellites in an orbit around the Earth

Third generation

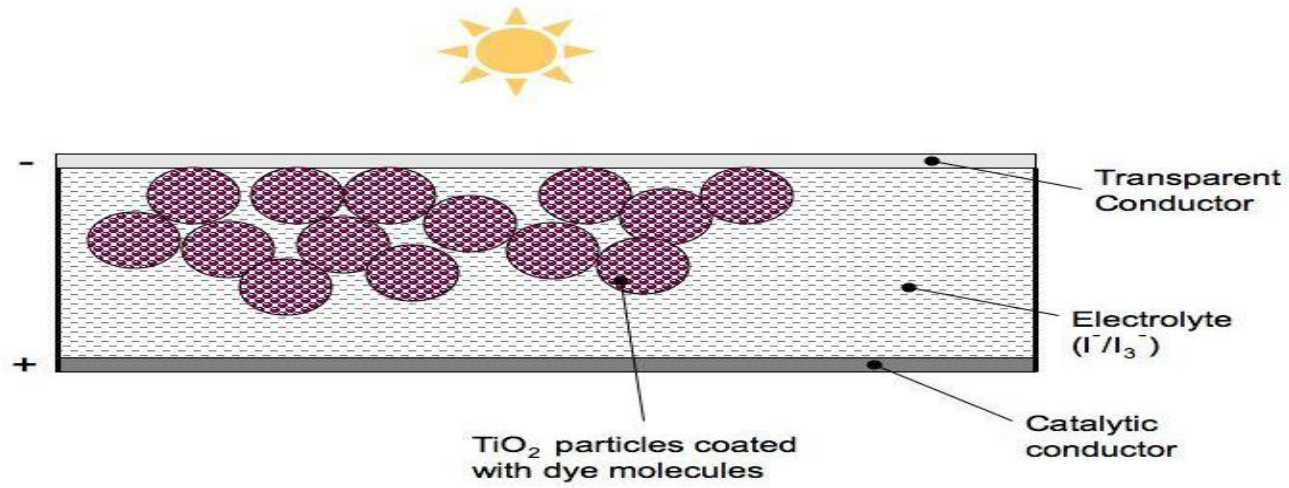

Dye-Sensitized Solar Cells

Polymer solar cell

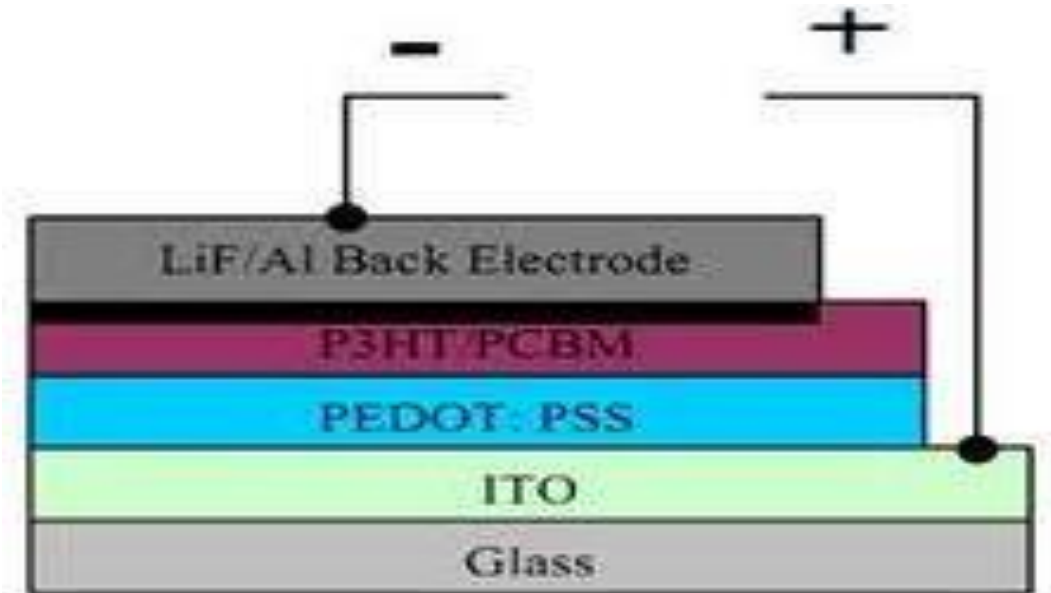
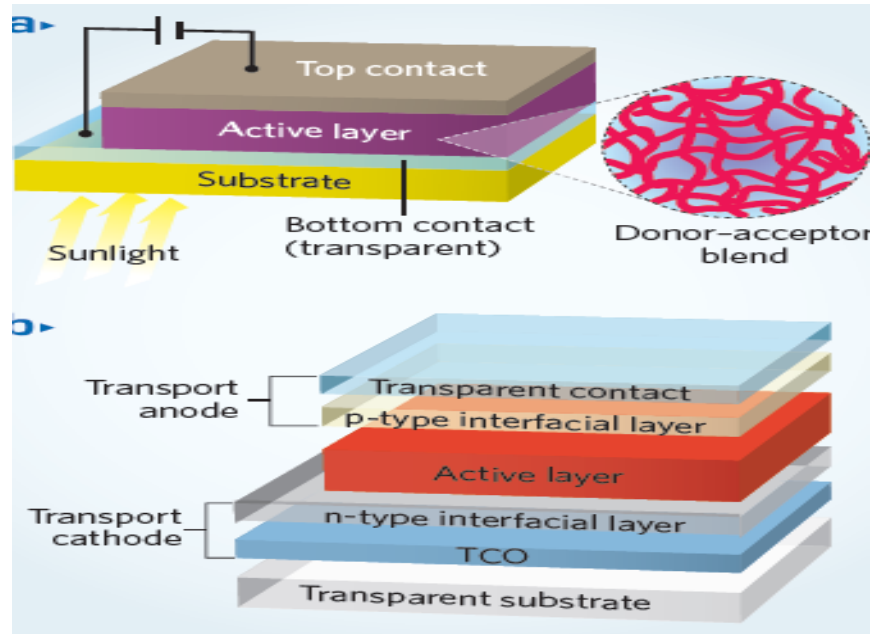

Working principle

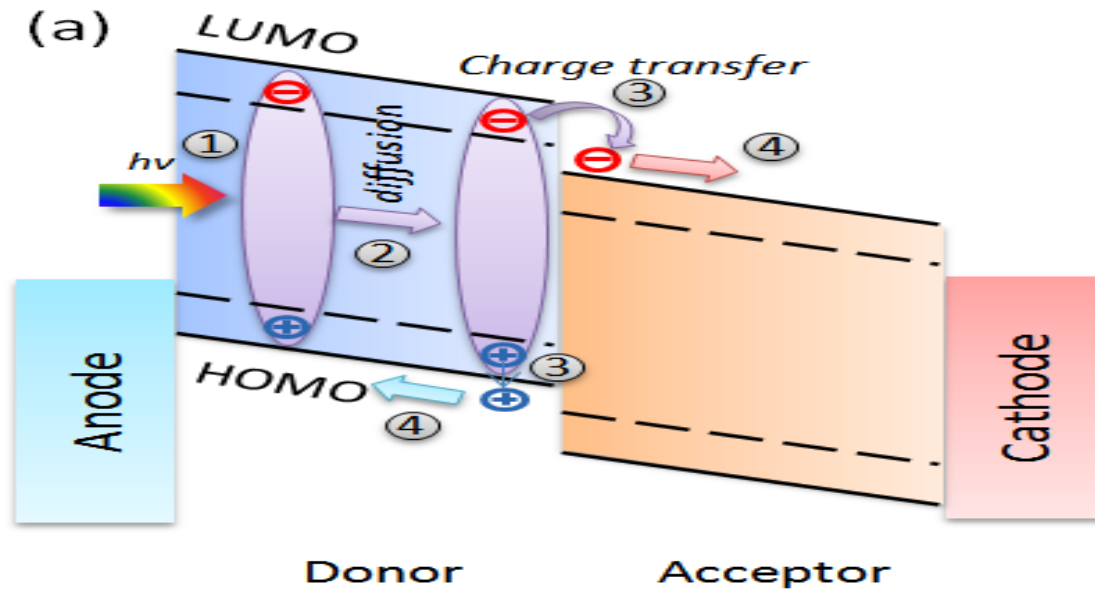

Photon absorption

Incident photons with energy ($h\nu$) are absorbed mainly by the donor material and excite the electrons from the HOMO to LUMO level, creating excitons

Charge transfer

Excitons dissociate at the Donor/Acceptor interface by charge transfer which is energetically favored:

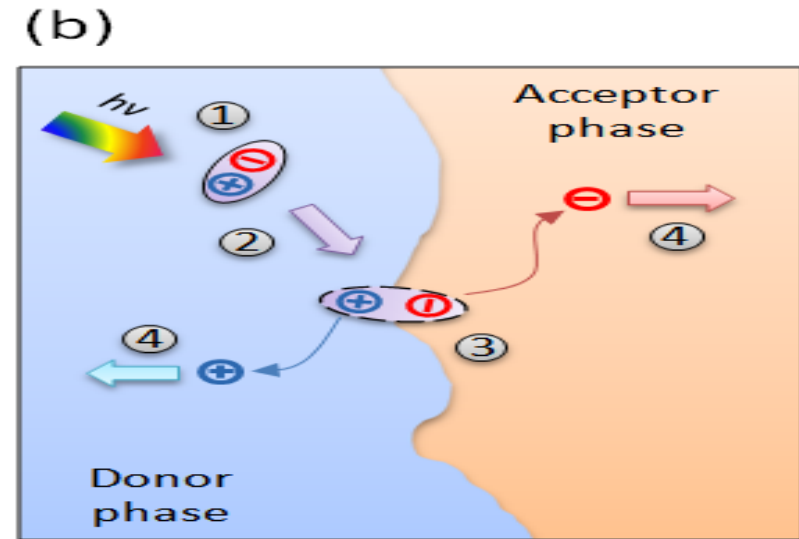

Exciton diffusion

excitons are neutral species, their motion is not affected by any electric field and they diffuse via random motion driven by the concentration gradient.

Charge carrier transport and collection

charge transfer has occurred at the D/A interface, separated holes and electrons are distributed within the donor and acceptor phases, respectively. Holes and electrons are then transport towards their respective electrode driven by an internal electric field

Polymer solar cell

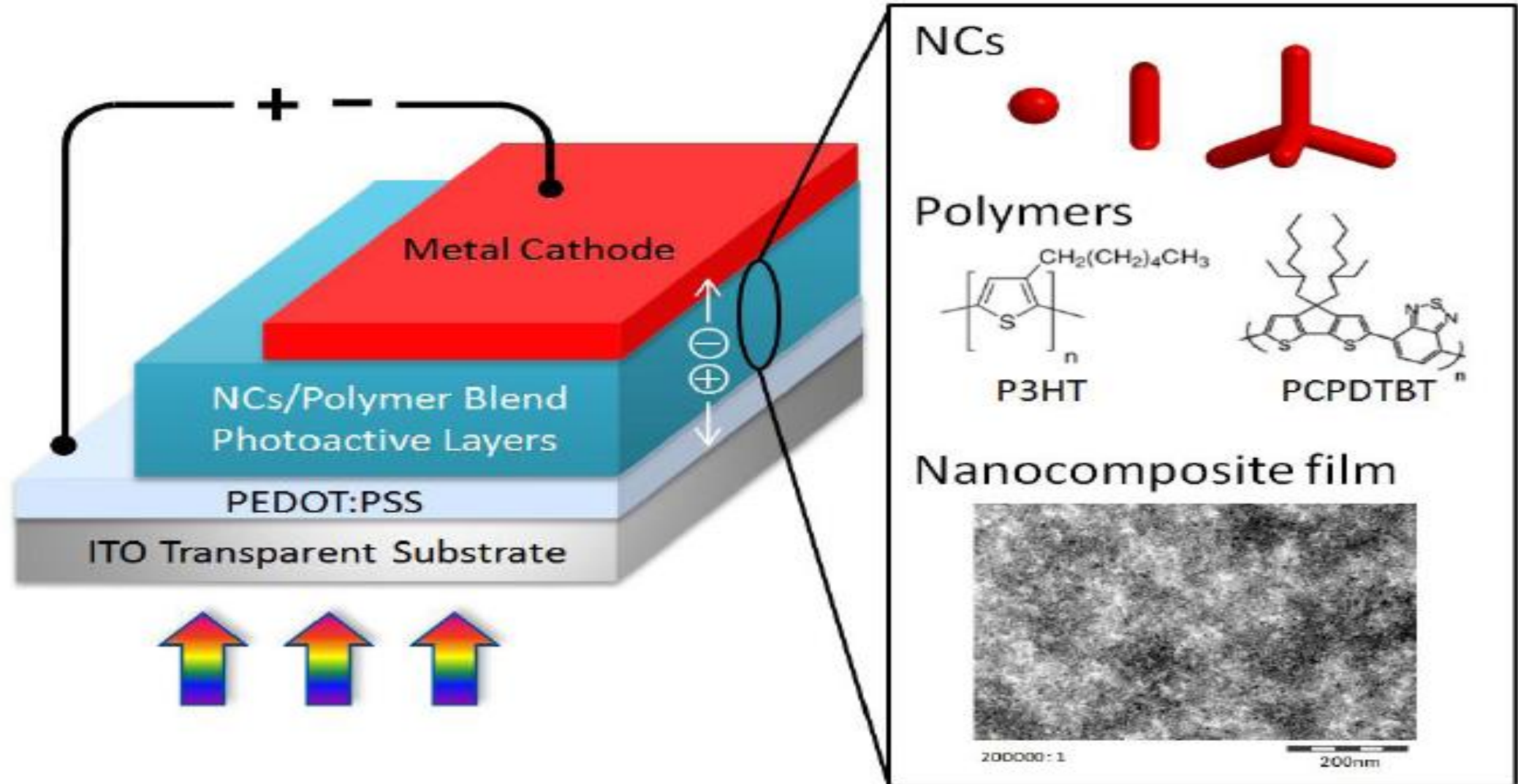

Polymer material

Electron Donor

MEH-PPV: *poly[2-methoxy-5-(2'-ethyl-hexyloxy)-1,4-phenylene vinylene]* **P3HT:** *poly(3-hexylthiophene)*

PFO-DBT: *poly[2,7-(9,9-dioctyl-fluorene)-alt-5,5-(4,7'-di-2-thienyl-2',1',3'-benzothiadiazole)]*

PCDTBT: *poly[N-9'-hepta-decanyl-2,7-carbazole-alt-5,5-(4',7'-di-thienyl-2'1',3'-benzothiadiazole)]*

P3HT: *Poly(3-hexylthiophene-2,5-diyl)*

Electron Acceptors

CN-MEH-PPV: *poly-[2-methoxy-5,2'-ethylhexyloxy]-1,4-(1-cyanovinylene)-phenylene*

F8TB: *poly(9,9'-dioctylfluorene-co-bis-N,N'-(4-butylphenyl)-bis-N,N'-phenyl-1,4-phenylenediamine)*

PC60BM: *6,6-phenyl-C61-butyric acidmethylester*

PC70BM: *6,6-phenyl-C71-butyric acidmethylester*

New polymers

- **PolyS** novel copolymer from benzodithiophene and alkyl sulfany l-bithiophene was used to fabricate bulk- hetero junction polymer solar cells (PSCs) in combination with the [60] PCBM and [70] PCBM (electron acceptors).
- **Monomer Used**

2,6-Bis(trimethyltin)-4,8-bis(2-ethylhexyloxy)benzo[1,2- b:4,5-b0]dithiophene

5,50-Dibromo-4,40-bis(octylsulfanyl)-2,20-bithiophene

There are various routes to synthesis donor monomer and acceptor monomer and then to do polymerization to get an active material polymer

Coating on single substrate

Spin coating

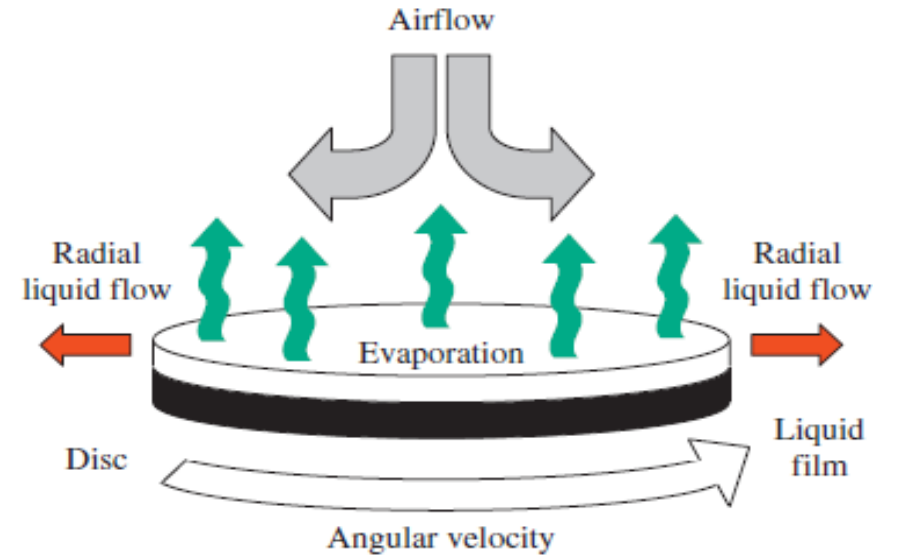
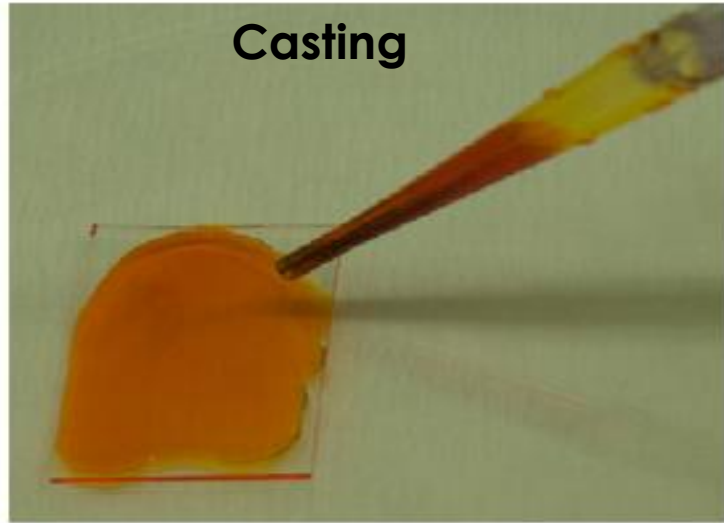

Doctor Blade



Screen printing

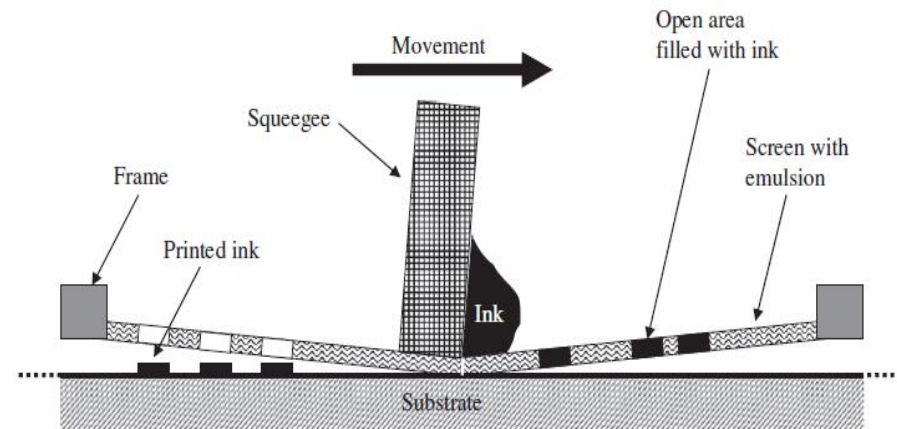

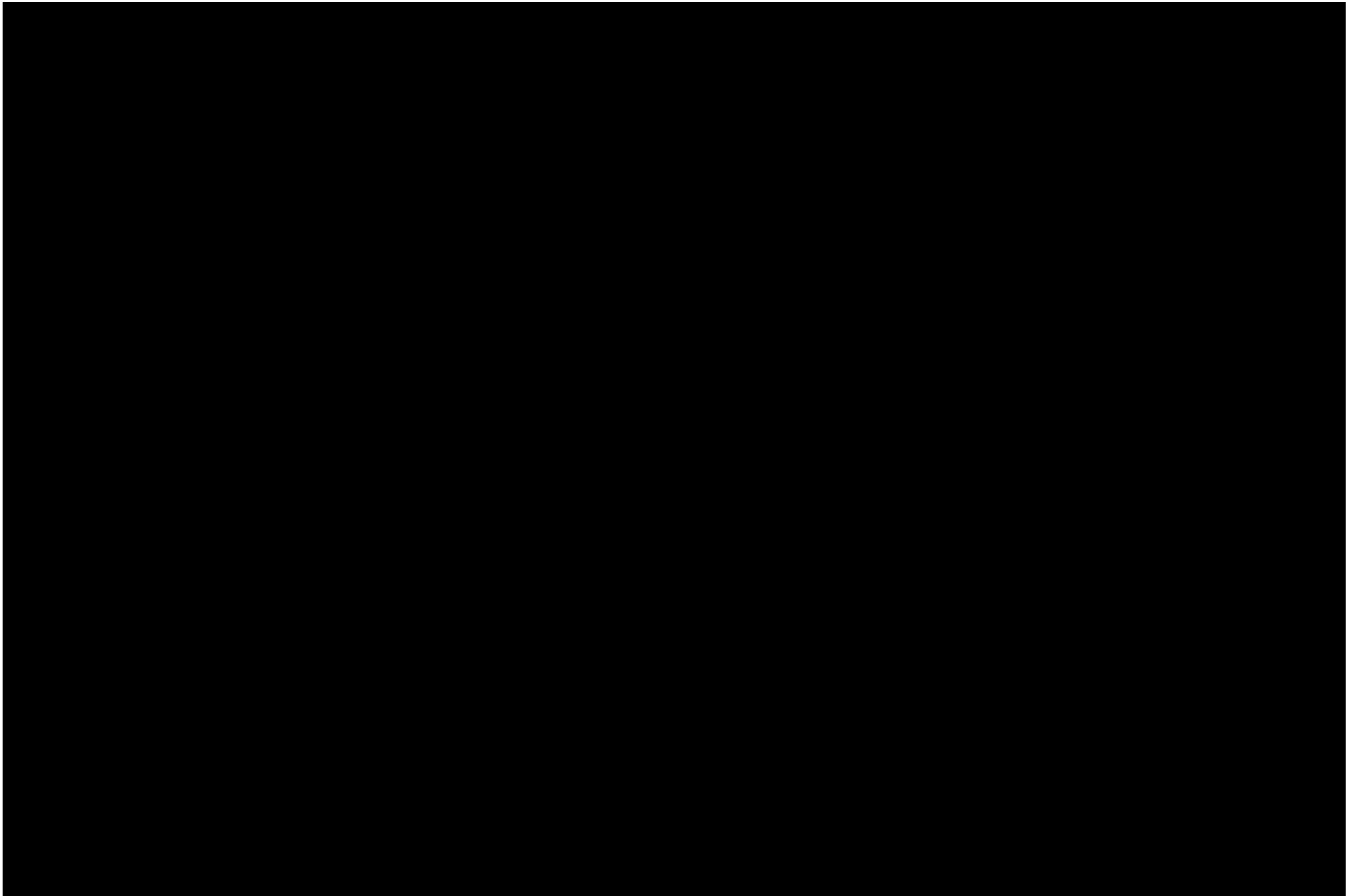

Fabrication of polymer solar cell

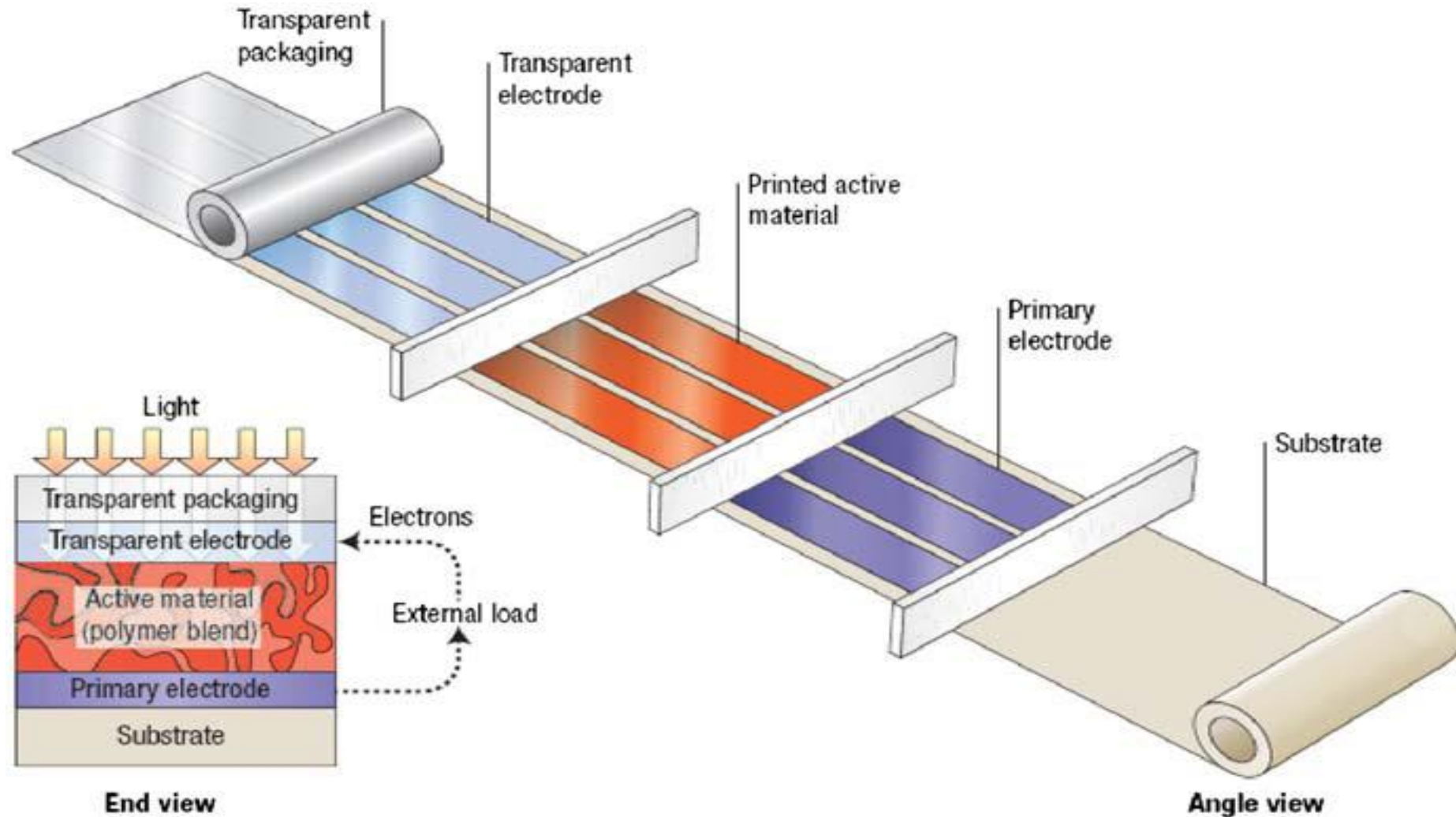

Roll to Roll

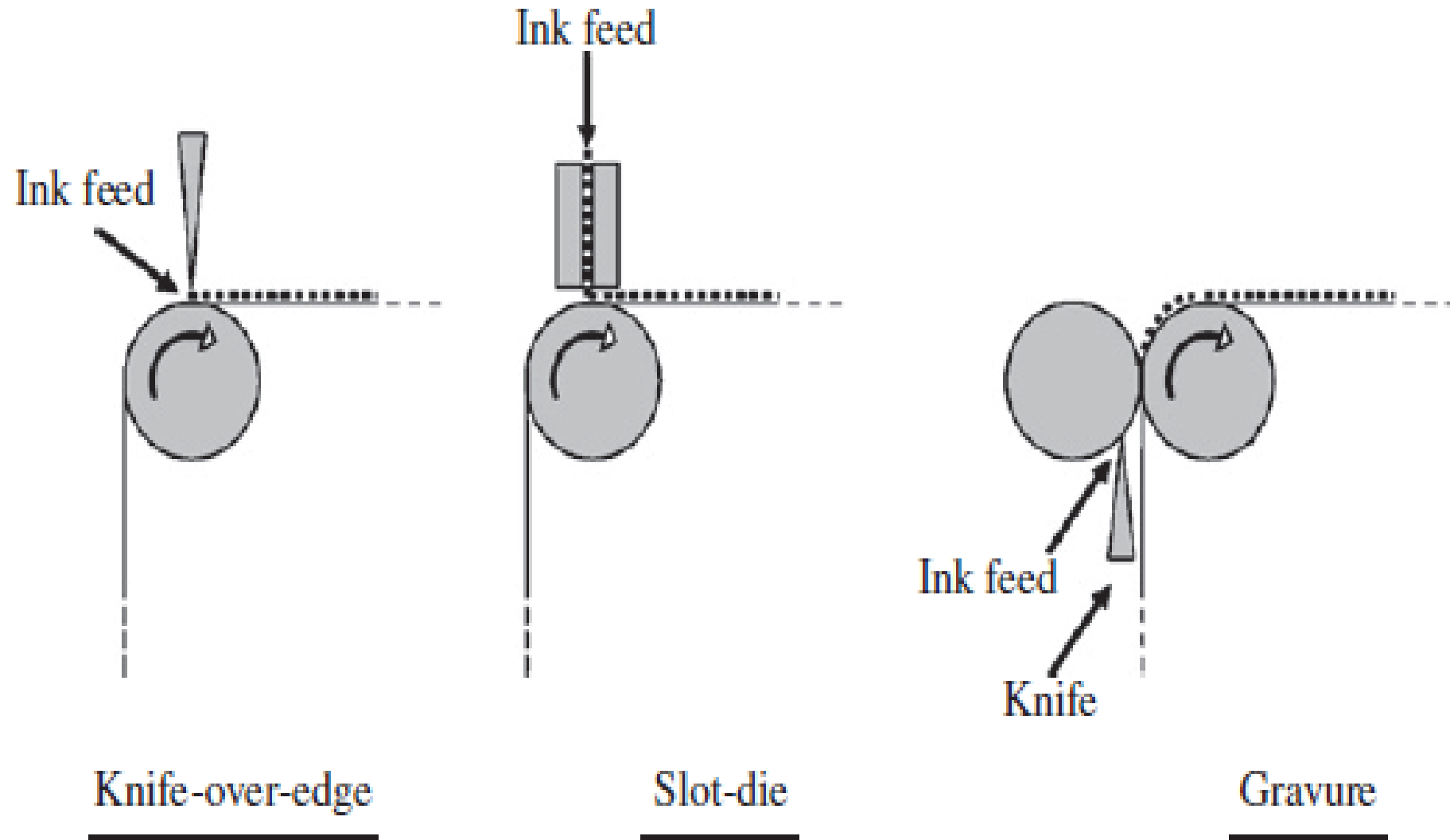

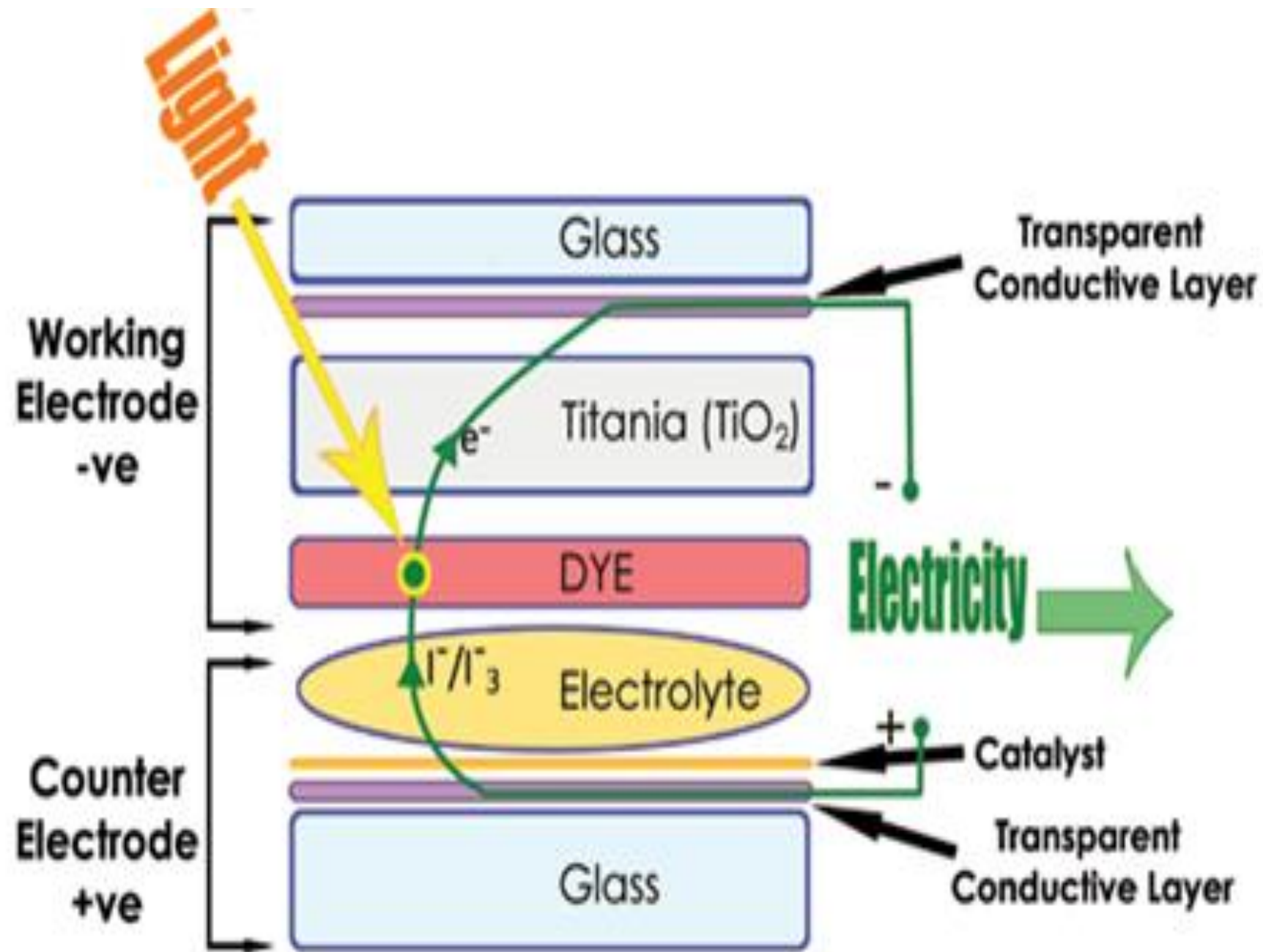

Steps in Lab Fabrication

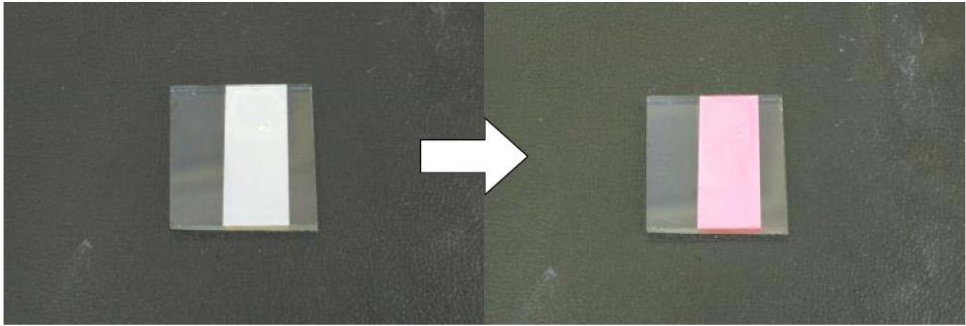
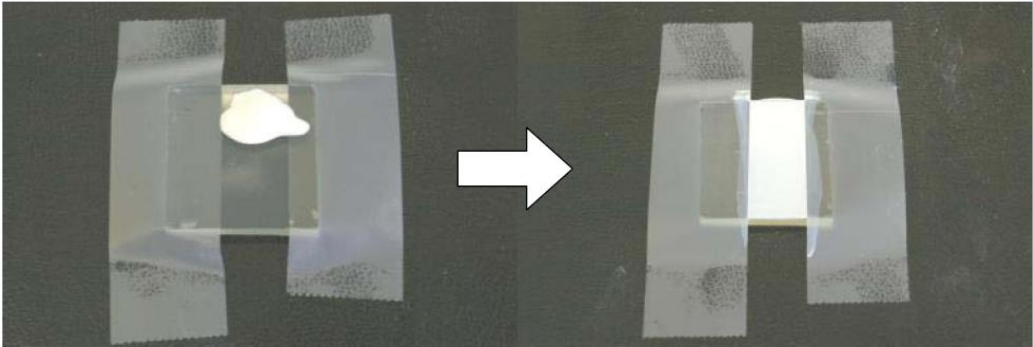

before dipping

after dipping

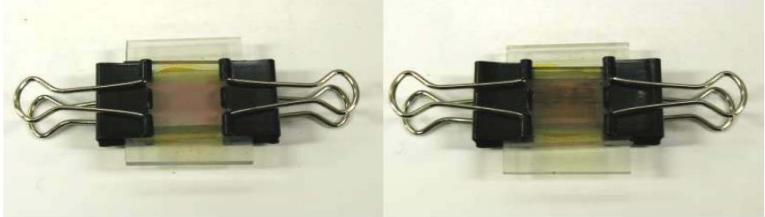
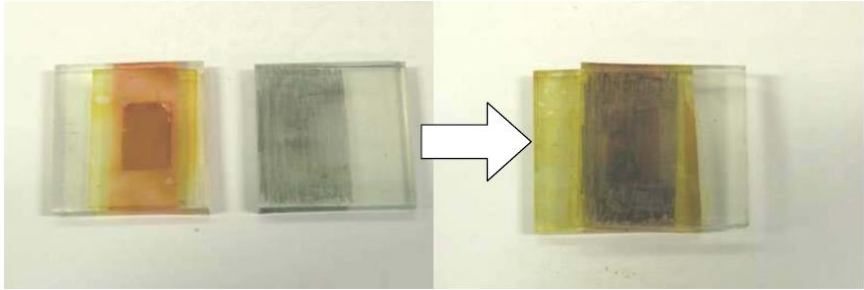
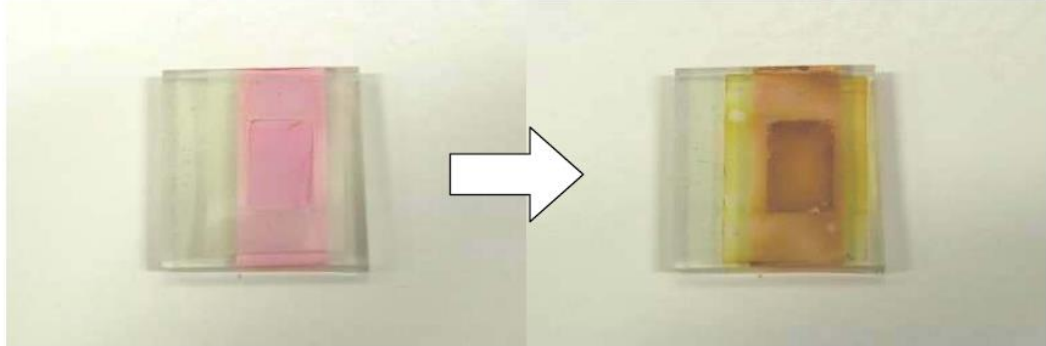

Front side (TiO₂/dye electrode)

Back side (counter electrode side)

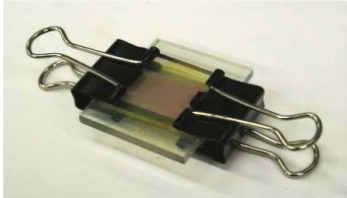

Natural dyes



Begonia

Tangerine peela

Rhododendrona

Fructus lyciia

Marigolda

Perillaa

Herba artemisiae scopariaea

China loropetala

Yellow rosea

Flowery knotweeda

Nanoimprinted Solar Cell

Mold prepared by nano imprint lithography .

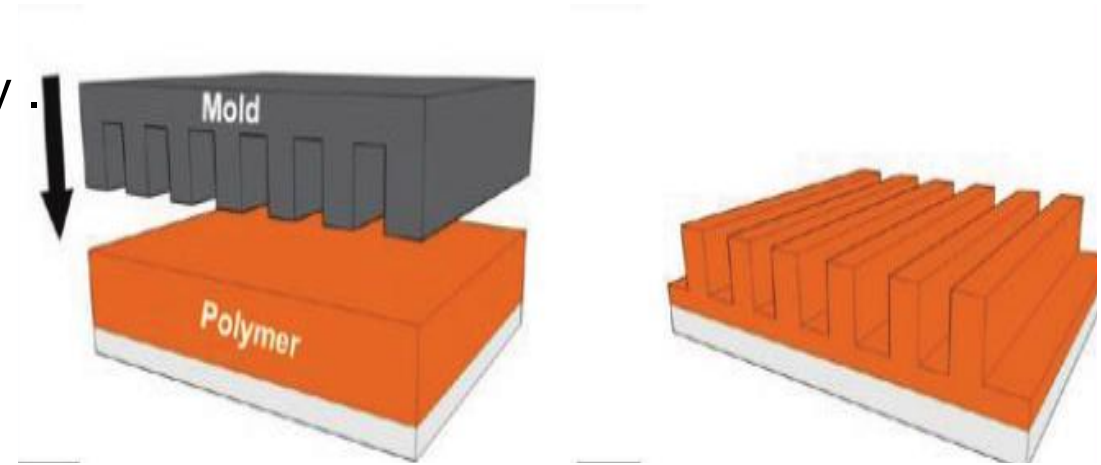
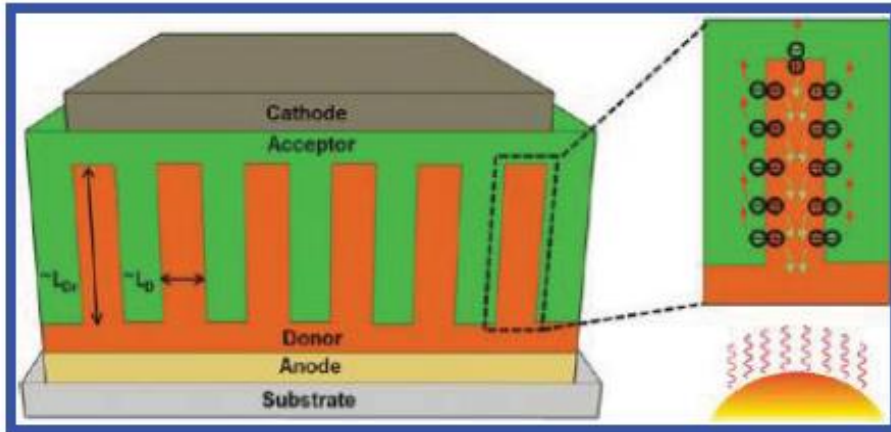

Monolayer Mold contacts with the polymer to be imprinted.

Under certain applied pressure and temperature, the polymer in the viscous state flows in the mold and forms nanostructures.

For nanoimprinted polymer solar cells, this temperature is important and usually set to be 50°C higher than the polymer's glass transition temperature (T_g), which changes the polymer from a rigid solid state into a viscous state and helps its flowing during imprinting.

Nanowire solar cells

The nanowires provide a direct conduction path for electrons between the point of photo generation and the conducting substrate. The devices have light harvesting efficiencies under 10%, indicating that current densities and efficiencies can be improved by an order of magnitude by increasing the nanowire surface area

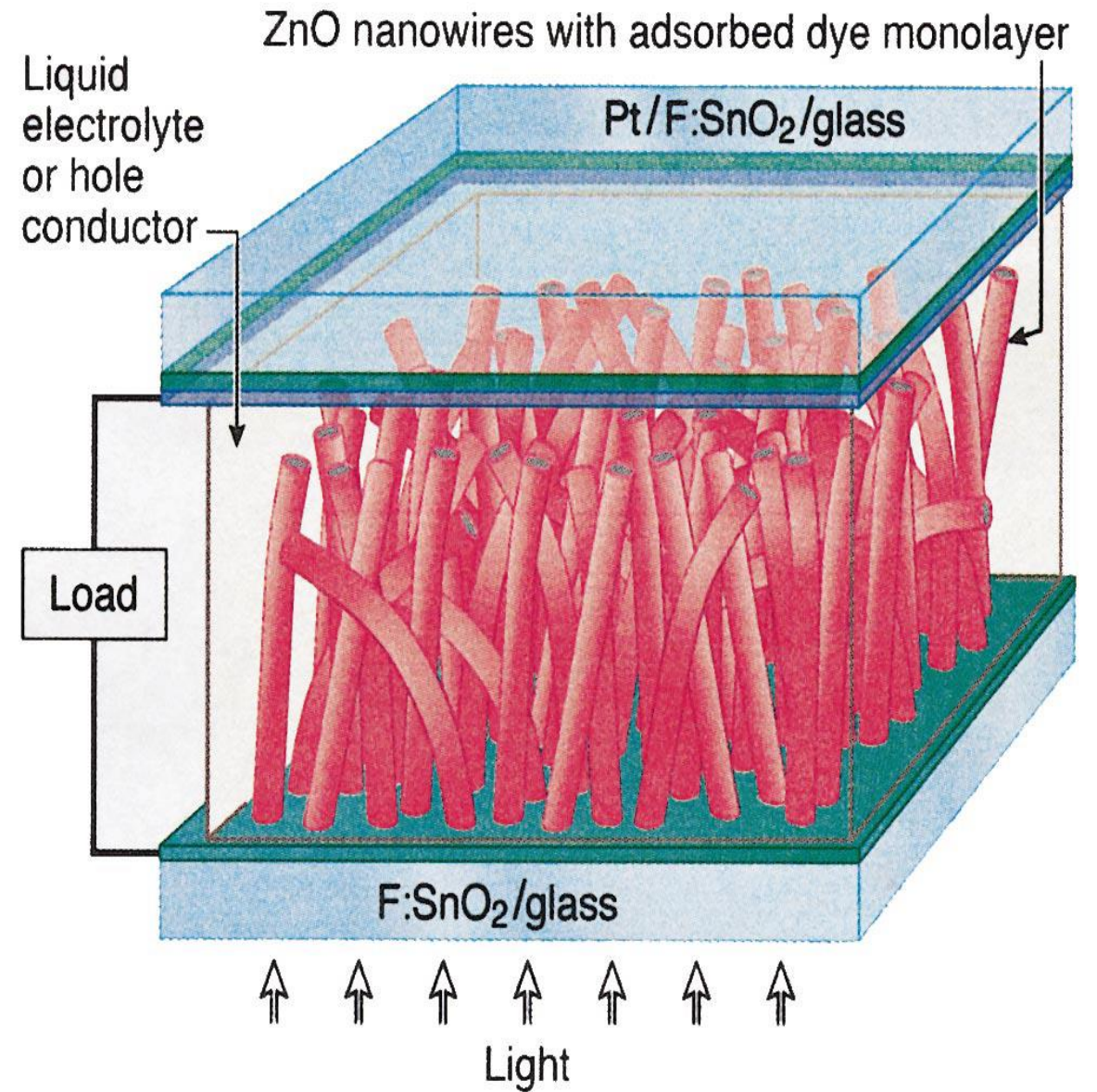

Fully spray-coated solar cells

The spray-coating method is able to access a broad spectrum of fluids
Helps to tune the system to deposit practically almost any kind of solution and obtain the desired film properties .

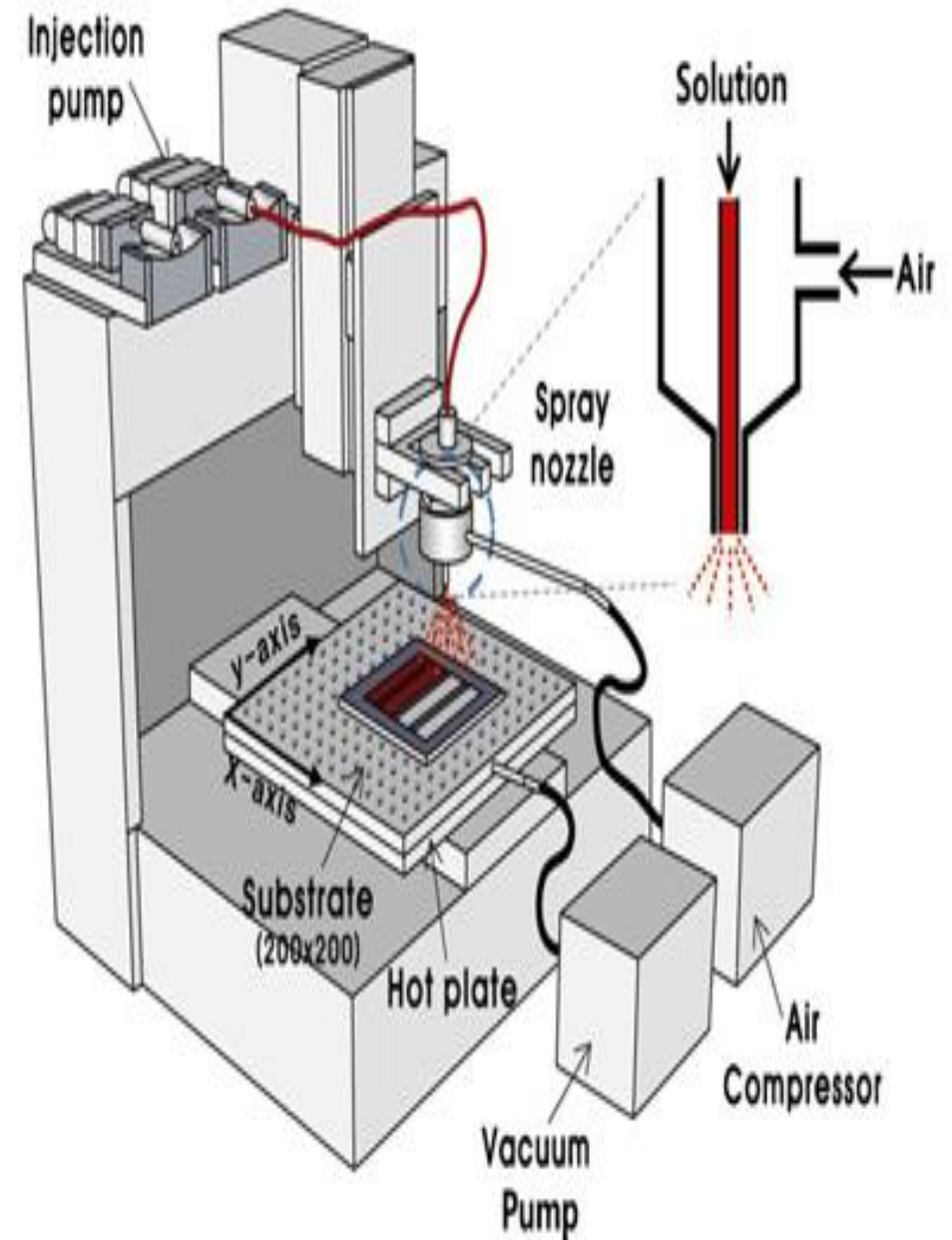

Hybrid Silicon Nanocone Polymer Solar Cells

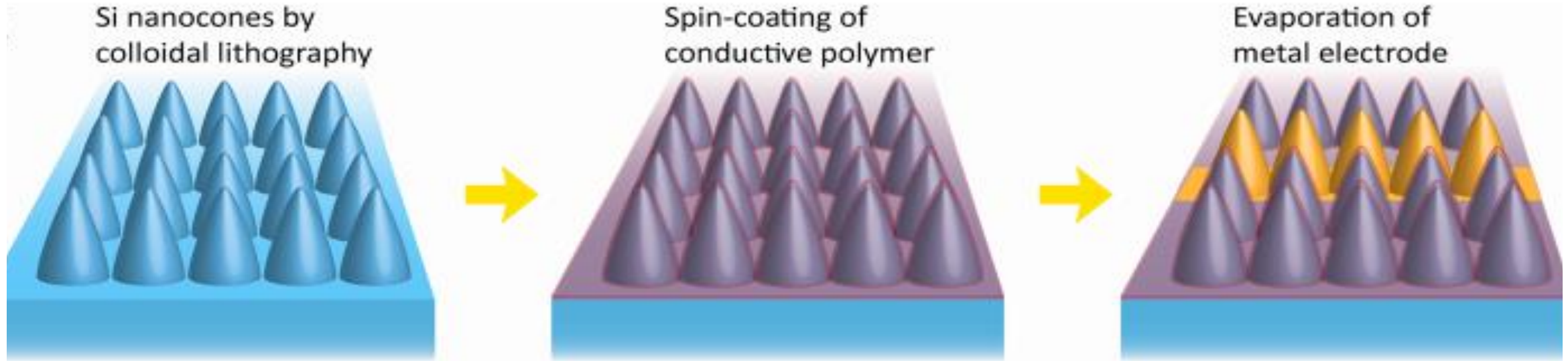

The Si nano cones were fabricated by nano sphere lithography. SiO₂ nanoparticles were deposited as a monolayer on a n-type Si substrate with a thickness of 500 μm. The polymer, can be deposited by spin-coating .The conformal coating of Polymer over the Si nano cones, other intermediate organic materials are not needed for full coverage.

Area Definitions

Total area: The total projected area of the cell or module. This is the preferred area for reporting of results

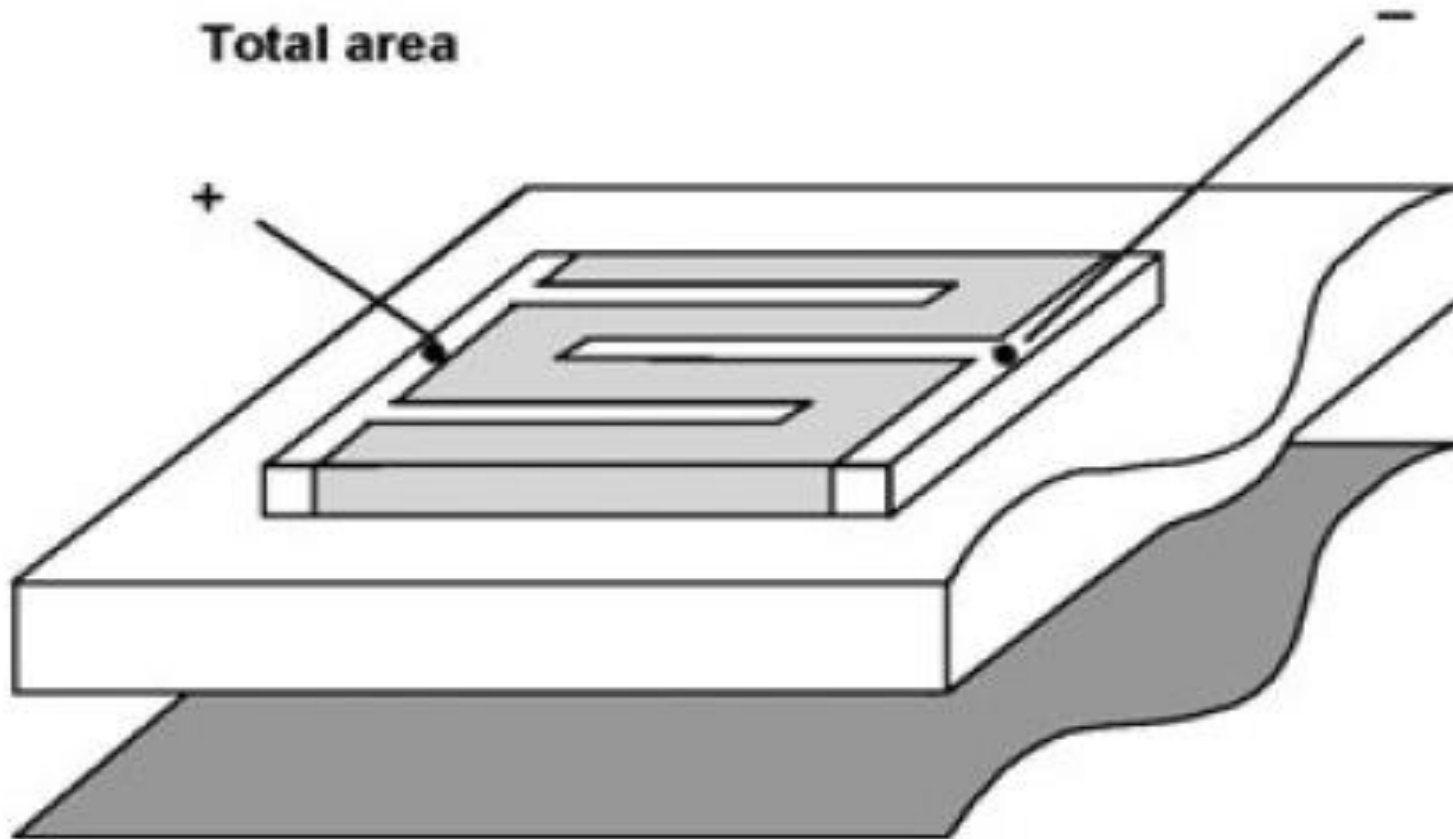

Aperture area: The portion of the total cell or module area that includes all essential components, including active material, fingers and interconnects. During testing, illumination is restricted to this portion .

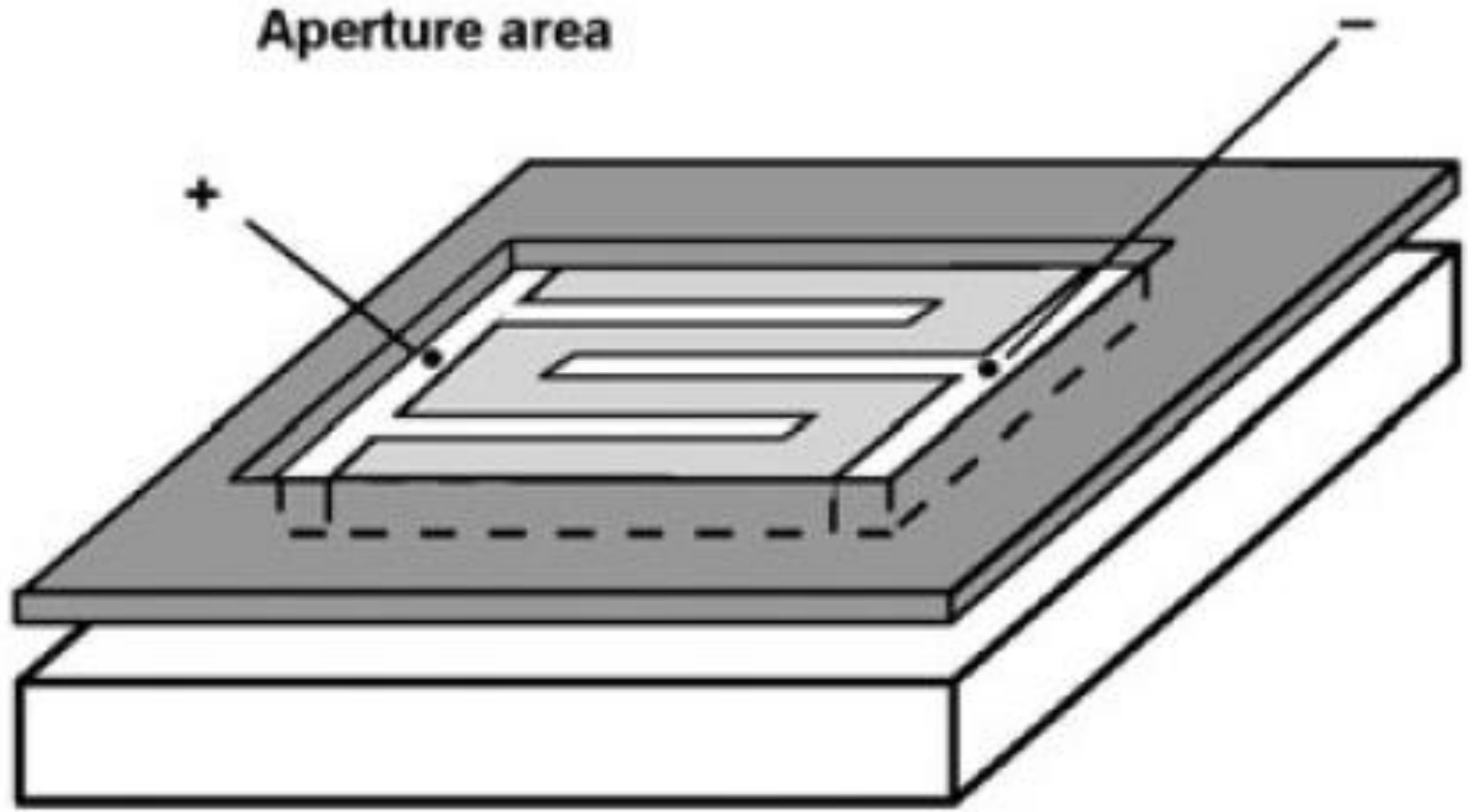

Designated illumination area: For a cell on insulating substrates, cell contacts may lie outside the designated illumination area. For modules, cell string interconnects may lie outside the masked area.

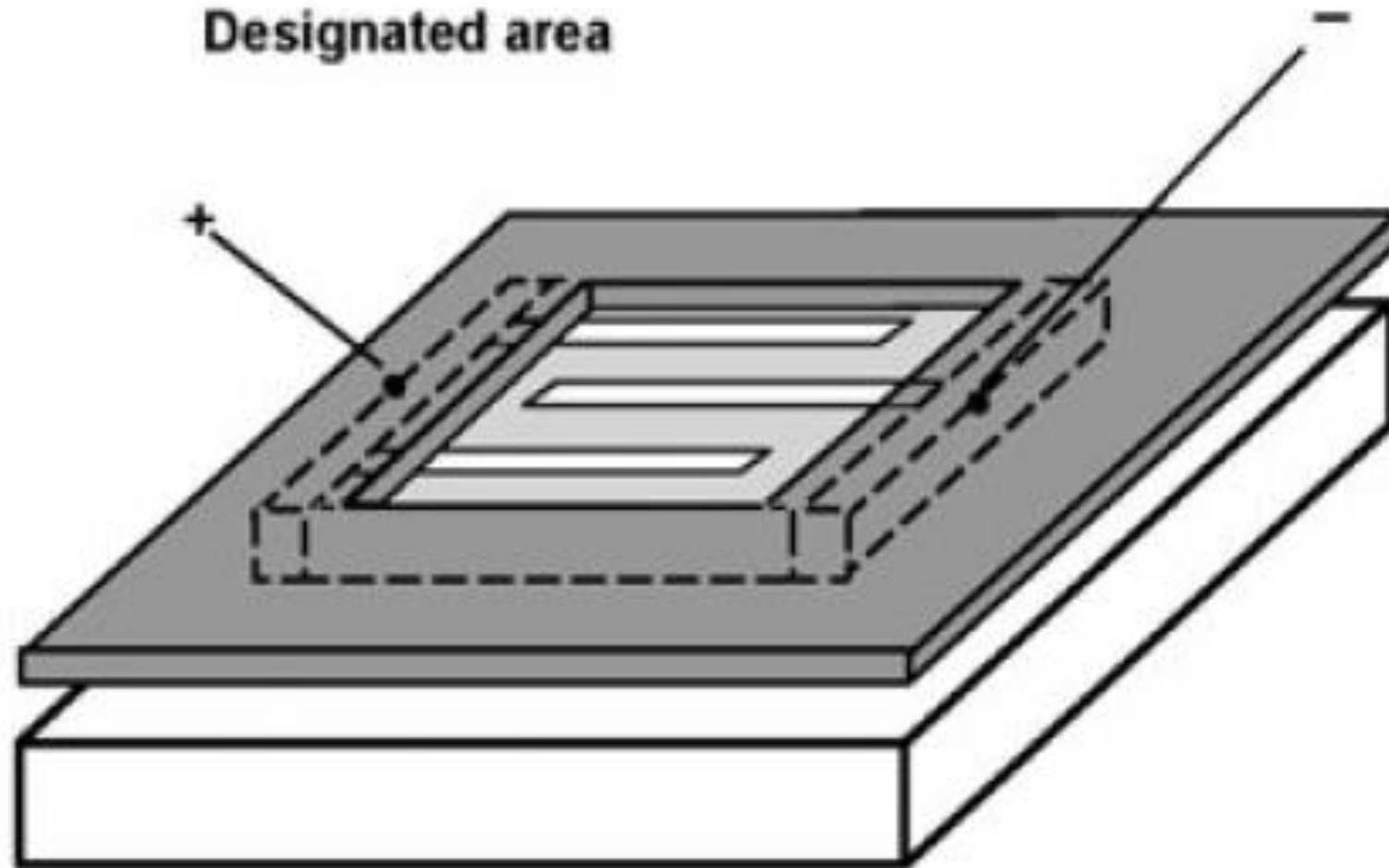

Characterization

Light

Source (solar simulator, halogen lamp, tungsten, laser source, real sun).

Intensity and intensity measurement

Temperature

Measurement (surface, substrate, surroundings).

Heating/cooling means (air circulation

Atmosphere

Ambient, vacuum, inert, glovebox (Humidity level, humidity control).

Electrical measurement

Conditions (IV-curves, J_{sc} , V_{oc} , conditions between measurements).

Number of measurement points, step speed and direction.

Efficiency table

<i>Silicon</i>	
Si (crystalline)	25.0 ± 0.5
Si (multicrystalline)	20.4 ± 0.5
Si (thin film transfer)	19.1 ± 0.4
Si (thin film submodule)	10.5 ± 0.3
<i>III-V cells</i>	
GaAs (thin film)	28.3 ± 0.8
GaAs (multicrystalline)	18.4 ± 0.5
InP (crystalline)	22.1 ± 0.7
<i>Thin film chalcogenide</i>	
CIGS (cell)	19.6 ± 0.6 ^k
CIGS (submodule)	17.4 ± 0.5
CdTe (cell)	16.7 ± 0.5 ^k
<i>Amorphous/nanocrystalline Si</i>	
Si (amorphous)	10.1 ± 0.3 ^m
Si (nanocrystalline)	10.1 ± 0.2 ⁿ
<i>Photochemical</i>	
Dye sensitised	11.0 ± 0.3 ^o
Dye sensitised (submodule)	9.9 ± 0.4 ^o
<i>Organic</i>	
Organic thin film	10.0 ± 0.3 ^o
Organic (submodule)	4.2 ± 0.2 ^o
<i>Multijunction devices</i>	
GaInP/GaInAs/Ge	34.1 ± 1.2
a-Si/nc-Si/nc-Si (thin film)	12.4 ± 0.7 ^p
a-Si/nc-Si (thin film cell)	12.3 ± 0.3 ^q
a-Si/nc-Si (thin film submodule) ^j	11.7 ± 0.4 ^{n,r}



**CASE
STUDY**

Laser Scribing Machine

The Laser Scribing Machine utilises a CO₂ laser, producing a continuous cut, which is used to remove the conductive oxide layer from glass substrates so that a series connect tile can be produced.

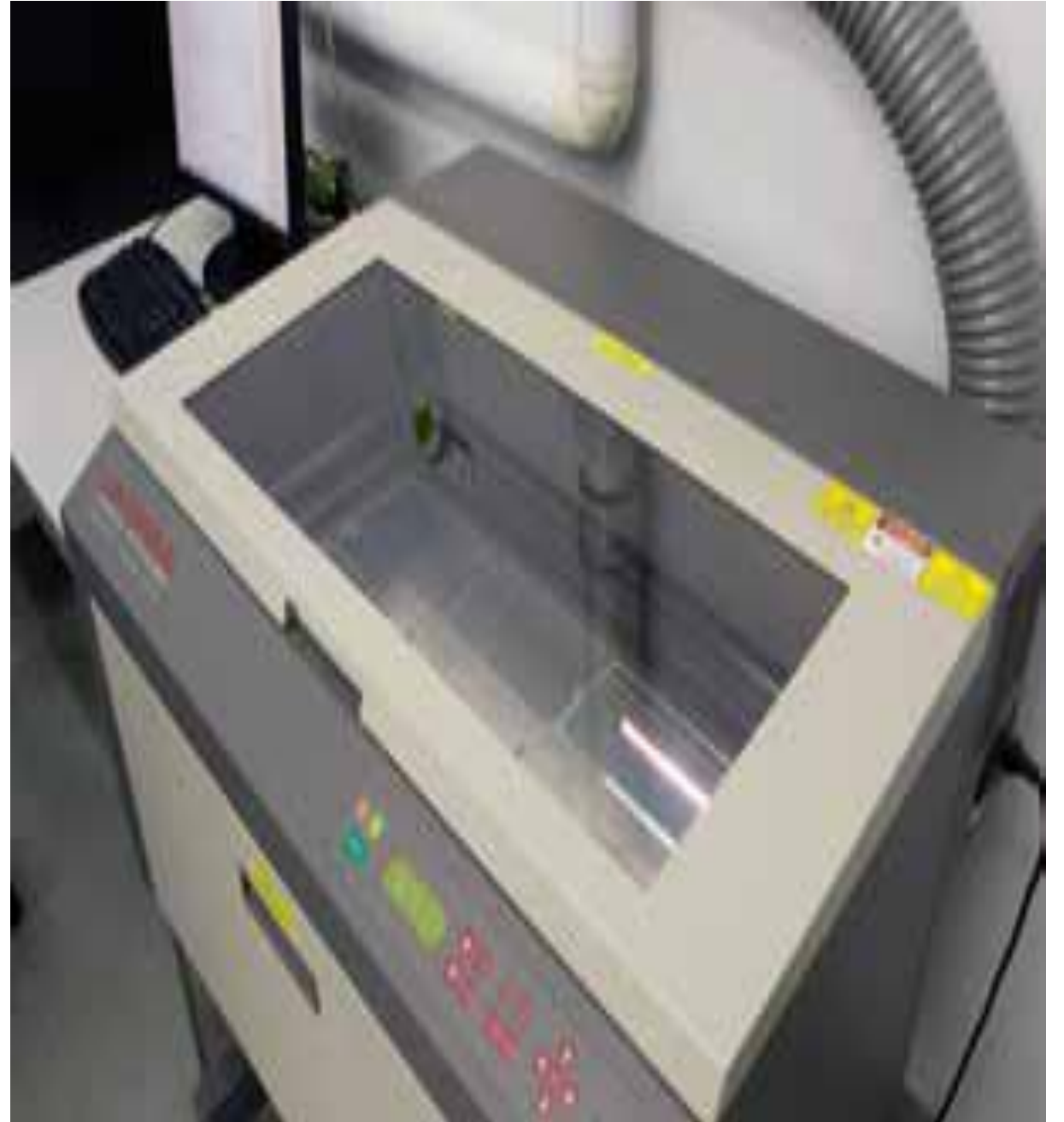

Automated Hole-Drilling Machine

The Automated Hole-Drilling Machine is used for creating electrolyte fill holes in glass substrates during the initial stage of glass electrode preparation.



Screen Printer

The Screen Printer is typically used for a catalyst paste to form the counter electrode and a semiconductor paste to form the working electrode. Controllable squeegee speed and pressure allow for precise and repeatable prints for both small and large production runs.



Laboratory Belt Furnace

The Laboratory Belt Furnace is used for glass conductor activation , working electrode and counter electrode pastes. operating temperature of approximately 550°C.



Dye Applicator

To Optimise dye absorption into the TiO₂ layer on the working electrode glass Dye solution is pumped through these tanks and re-circulated through a central reservoir. The flow of dye solution is manipulated to produce uniform flow of the dye across the working electrodes.



Electrolyte Filling Machine

This version fills one cell at a time, using an upward facing head block. Electrolyte can be recovered and recycled from the internal plumbing and head cavities, so this machine minimises electrolyte wastage.



Atoms in a Crystal

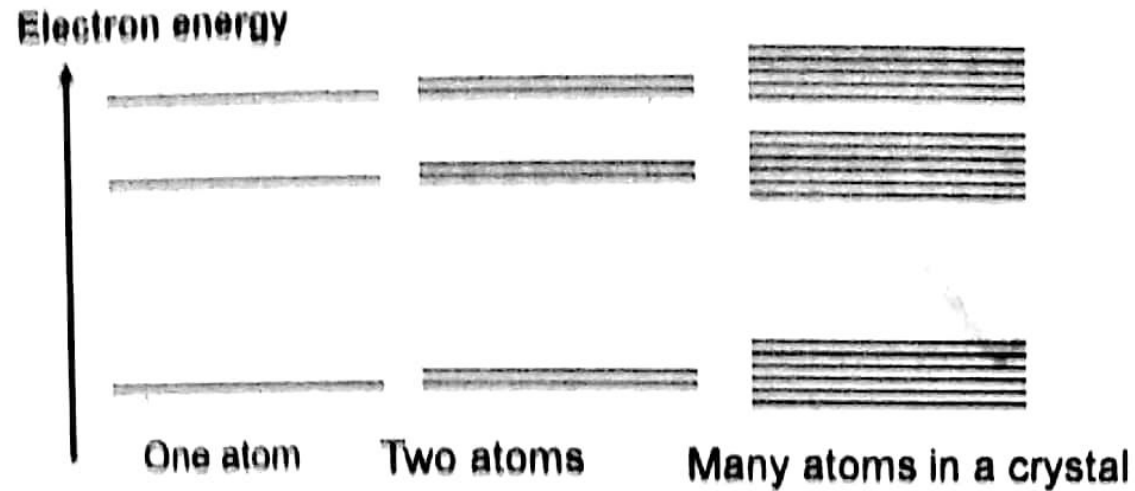

- When atoms are brought together to form a solid, the nearby atoms interact

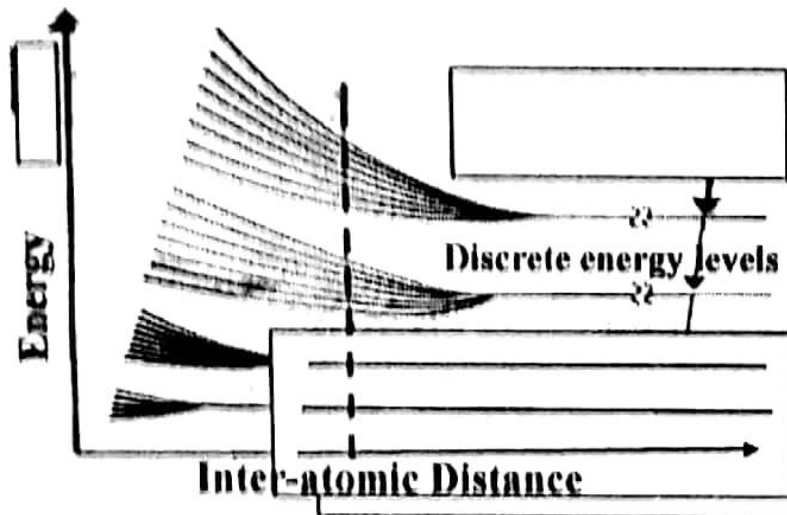

- As the distance between the atom approaches equilibrium inter-atomic distance for a given material, energy bands forms
- Each band can accommodate $2N$ electrons, where N is the number of atoms in the crystal

Metal, Insulator, Semiconductor

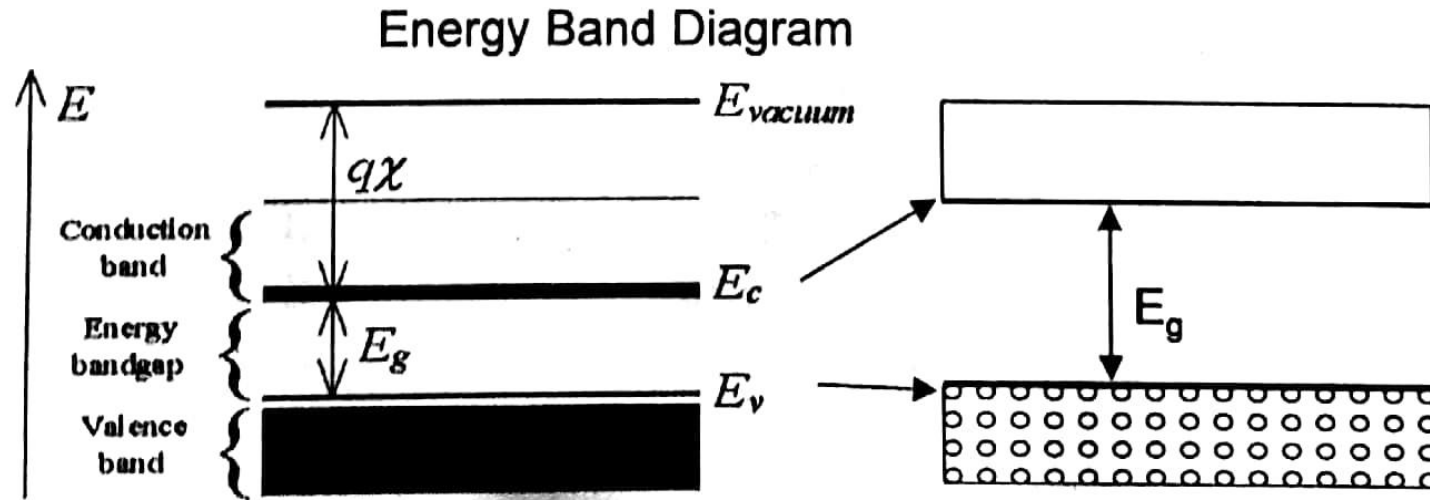

Valence Band, Conduction Band, Energy Bandgap, Vacuum level

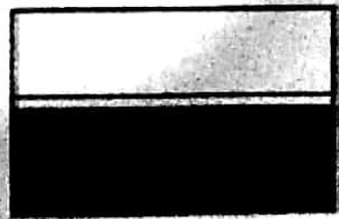

Metal

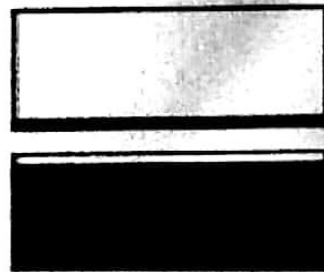

Semiconductor

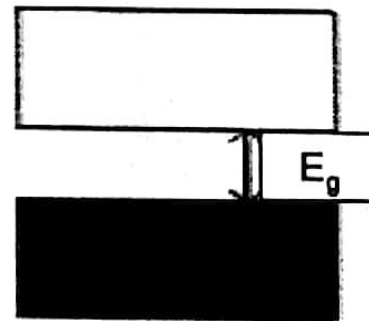

Insulator

Charge Carriers in Semiconductors

- At a temperature of 0 K, a semiconductor behaves like an insulator
- At a temperature $> 0\text{K}$, thermal energy transfers some electrons from valence band to conduction band, thus producing *free* electrons & holes

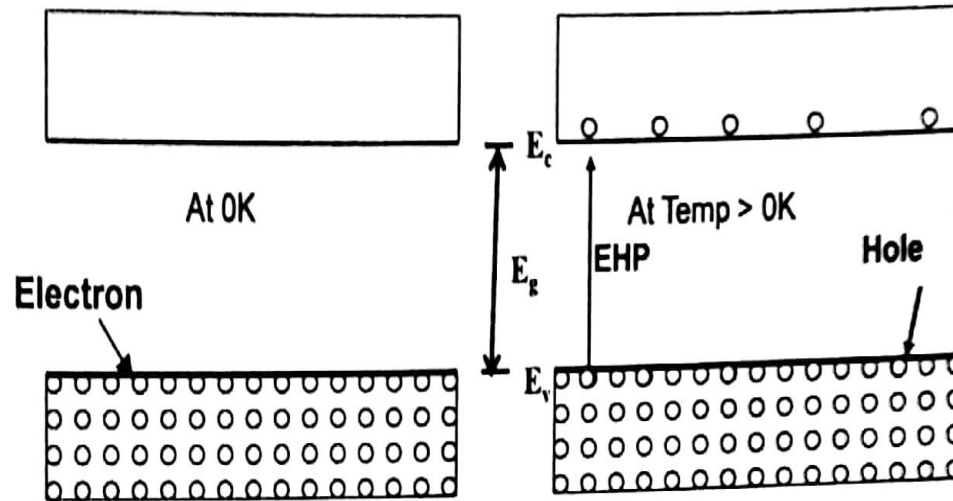

- Empty state in VB is *hole*, regarded as a free particle with positive charge.
- For Si, $E_g = 1.1\text{ eV}$, for Ge, $E_g = 0.7\text{ eV}$, for GaAs $E_g = 1.4\text{ eV}$

Commonly Used Semiconduct

			IIIA	IVA	VA	VIA	VIIA	VIIIA
			5	6	7	8	9	10
			B	C	N	O	F	Ne
			10.811	12.011	14.007	15.999	18.998	20.183
			13	14	15	16	17	18
			Al	Si	P	S	Cl	Ar
			26.982	28.086	30.974	32.064	35.453	39.948
IB	IIB							
20	30	31	32	33	34	35	36	
Cu	Zn	Ga	Ge	As	Se	Br	Kr	
63.54	65.37	69.72	72.59	74.922	78.95	79.909	83.80	
47	48	49	50	51	52	53	54	
Ag	Cd	In	Sn	Sb	Te	I	Xe	
107.870	112.40	114.82	118.69	121.75	127.60	126.904	131.30	
79	80	81	82	83	84	85	86	
Au	Hg	Tl	Pb	Bi	Po	At	Rn	
196.967	200.59	204.37	207.19	208.980	(209)	(210)	(222)	

A semiconductor can be either of a single element, such as Si or Ge, a binary compound such as GaAs, InP or CdTe, or a ternary compound, such as GaInAs

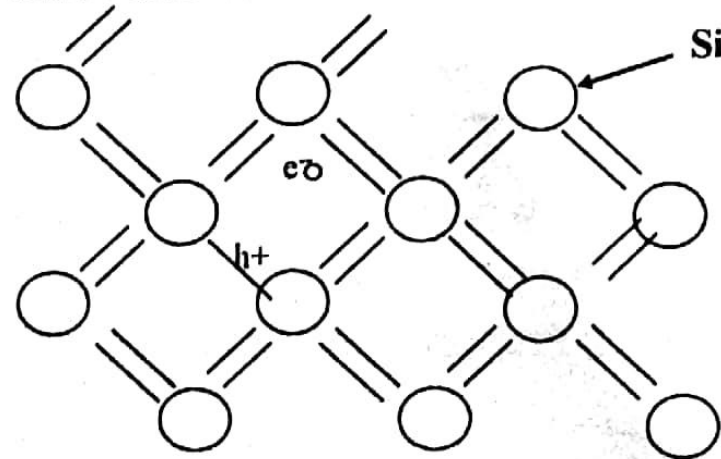

In intrinsic (or pure) silicon, the number of carriers n_i is determined by the equilibrium between generation and recombination

$$n_i = A T^{3/2} \exp(-E_g/2kT) \quad \text{varies}$$

$$n_i = 10^{10} \text{ cm}^{-3} \text{ at room temperature}$$

The Fermi Level

Distribution of electrons over the range of allowed energy levels at the thermal equilibrium is given by *Fermi function*

$$f(E) = \frac{1}{1 + e^{(E - E_F) / kT}} \sim \exp(-E / kT)$$

Fermi

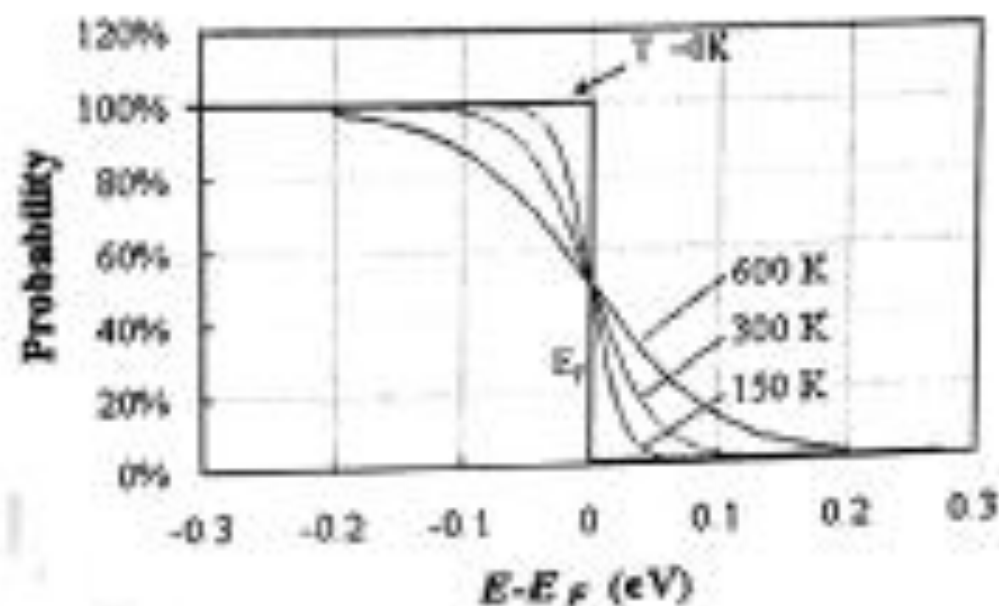

The function $f(E)$ gives the probability that an available energy state at E will be occupied by an electron at temperature T .

Density of states $\propto \sqrt{E - E_c}$ Conduction band

$\propto \sqrt{E_v - E}$ Valence band

Carrier concentrations

Band diagram

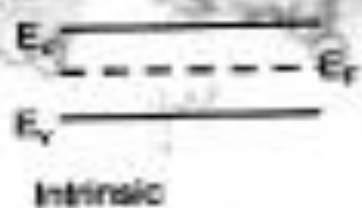

Density of states

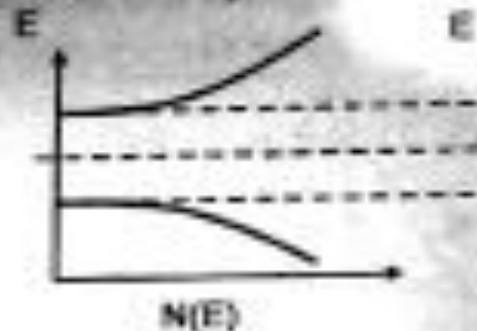

Fermi-Dirac distribution

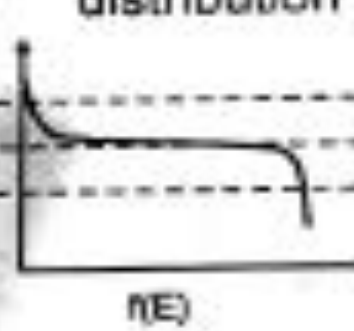

Carrier concentration

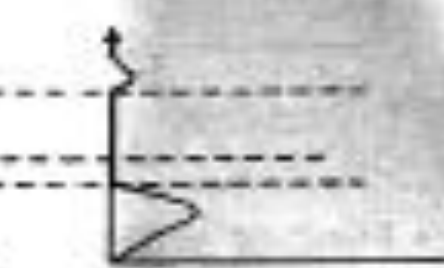
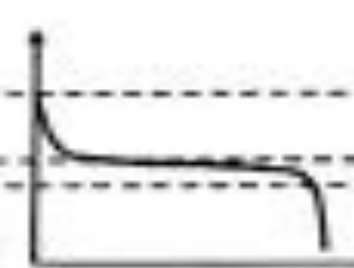
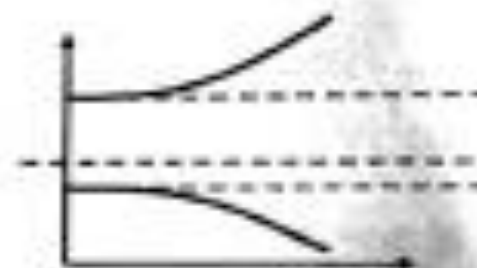
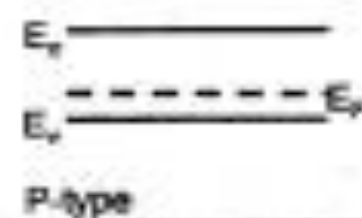
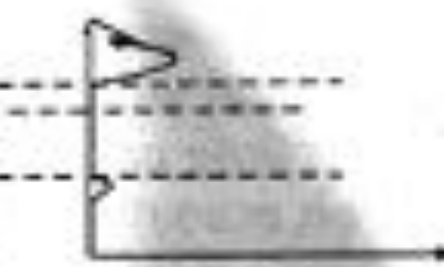
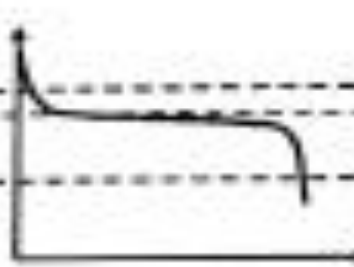
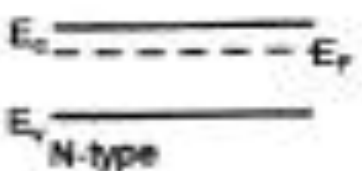
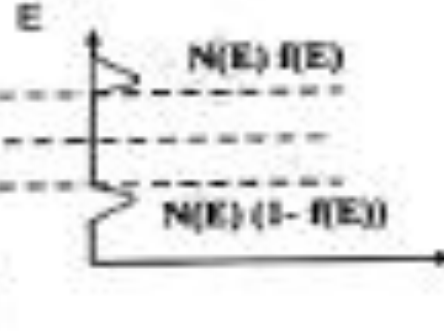

Equilibrium Carrier Concentration

Energy density of allowed states:

- Within forbidden zone: $N(E) = 0$
- In Conduction band, $N(E) = \text{Constant} * (E - E_c)^{1/2}$
- In valence band $N(E) = \text{Constant} * (E_v - E)^{1/2}$

*we can
also
w.*

Carrier density $n_0, p_0 = \text{density of states} * \text{Occupation probability}$

$$n_0, p_0 = \int f(E)N(E)dE$$

Equilibrium electron concentration

$$n_0 = N_c e^{(E_F - E_c)/kT}$$

Equilibrium hole concentration

$$p_0 = N_v e^{(E_v - E_F)/kT}$$

Where N_c, N_v effective density of states

$$n_0 p_0 = n_i^2$$

*more steps
im*

Current Flow: Drift

Carrier Drift

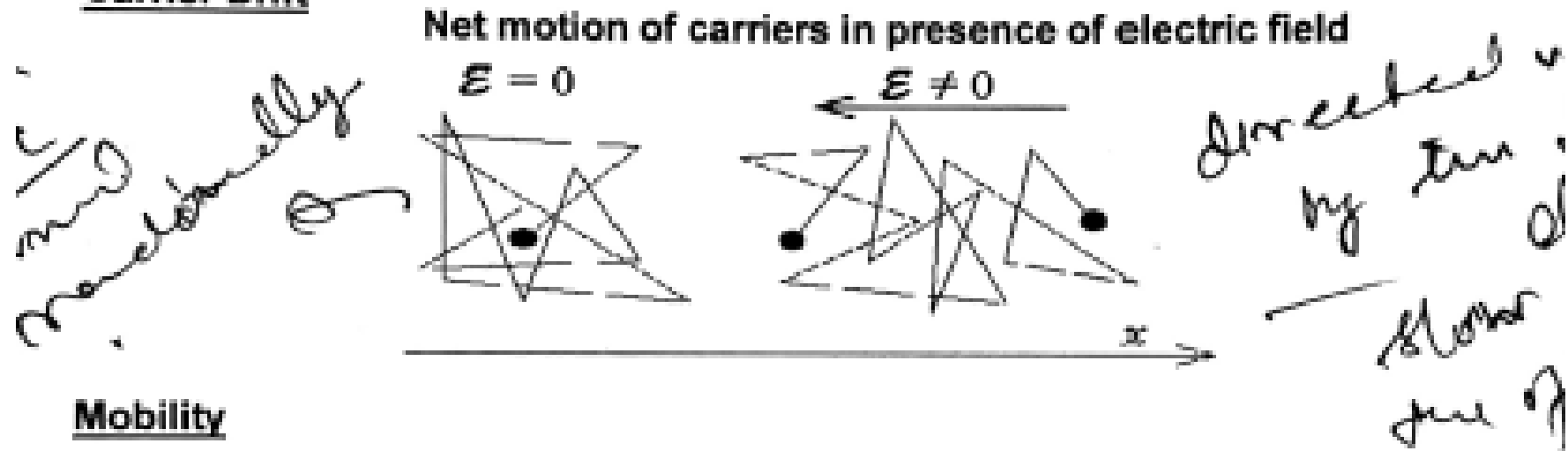

Mobility

Collision with atom in solid impedes the movement of carriers, after a short time carrier reaches a constant velocity, (*drift velocity, v_d*) for a given electric field

The ease with which carrier flow is defined as *mobility* :

mobility (μ) = drift velocity, v_d / electric field strength, E

$$\mu = v_d / E \quad \text{cm}^2/\text{V}\cdot\text{s}$$

- Higher impurity and temperature leads to lower mobility

Drift of Carriers

Current Density

- Current density due to electron and hole flow will be

$$J_n = q n v_d = q n \mu_n E$$

$$J_p = q p v_d = q p \mu_p E$$

Direction of the currents:



- Total current will be the some of hole and electron current

$$\text{Total Current density } J_{\text{total}} = J_n + J_p$$

$$J = q n \mu_n E + q p \mu_p E = q (n \mu_n + p \mu_p) E$$

Conductivity

- According to ohm's law,

$$\text{Conductivity } \sigma = J_{\text{total}} / E \quad (\Omega\text{-cm})^{-1}$$

$$\text{Conductivity } \sigma = q (p \mu_p + n \mu_n)$$

*Conductivity
is called
sigma*

Diffusion of carriers

- Motion of carriers from high concentration to low concentration, due to random physical motion of carriers

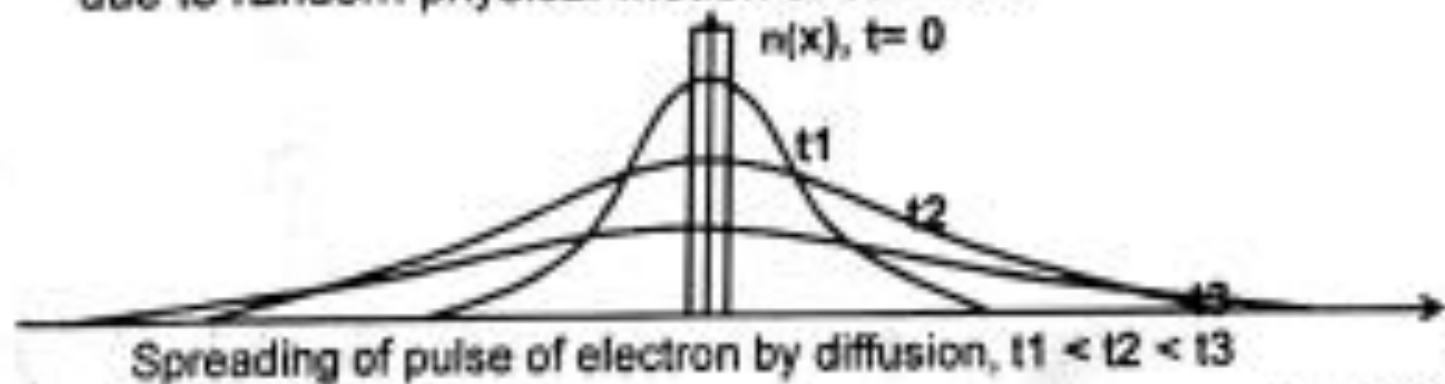

Ficks Law

- Current flow due to diffusion is given by:

$$J_n = qD_n \frac{dn}{dx}$$

$$J_p = -qD_p \frac{dp}{dx}$$

D_n, D_p is the diffusion coefficient

more / were slightly dependent in gen

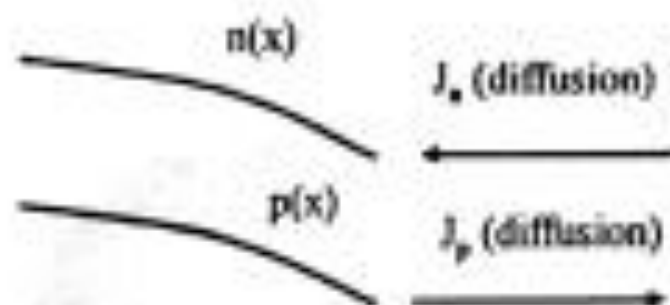

Total Current in a Semiconductor

Total Current J

= Electron current (drift, diffusion) + Hole current (drift, diffusion)

Handwritten: $J_n = q n \mu_n E + q D_n \frac{dn}{dx}$

drift
diffusion

$J_p = q n \mu_p E - q D_p \frac{dn}{dx}$

$J = J_p + J_n$

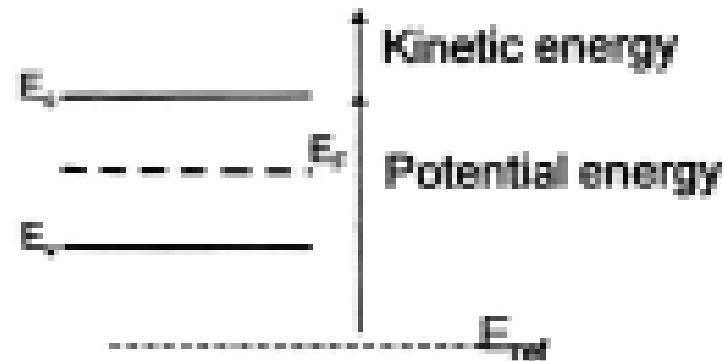

Band bending

$PE = -qV = PE_c - PE_{ref}$

$E = -dV/dx \rightarrow$

$$E = \frac{1}{q} \frac{dE_c}{dx} = \frac{1}{q} \frac{dE_v}{dx}$$

Einstein relation

Under equilibrium, $J_n = 0$

$$\frac{D_n}{\mu_n} = \frac{kT}{q}$$

Relationship between the constants from drift and diffusion

Generation of carriers

- Absorption of radiation cause excitation of a valence hole into conduction band, thus creation of EHP

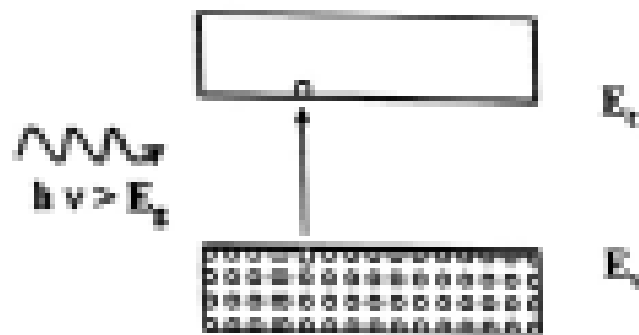

- **Direct bandgap semiconductor:** excitation of carrier requires change in energy. Ex: GaAs, CdTe
- **Indirect bandgap semiconductor:** excitation of carrier requires change in energy as well as momentum. Ex: Si, Ge

photon transfer its energy

*more direct
at the
equilibrium
no two
metals.*

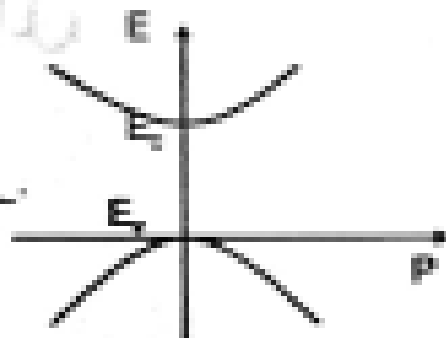

Direct Semiconductor
High absorption probability

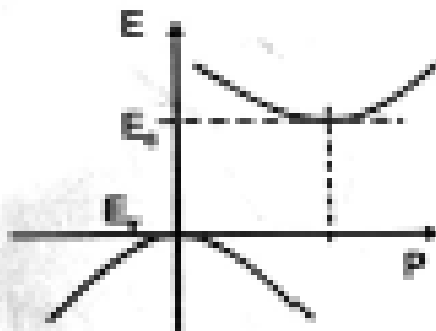

Indirect Semiconductor
Low absorption probability

Si

not emit

Recombination of Carriers

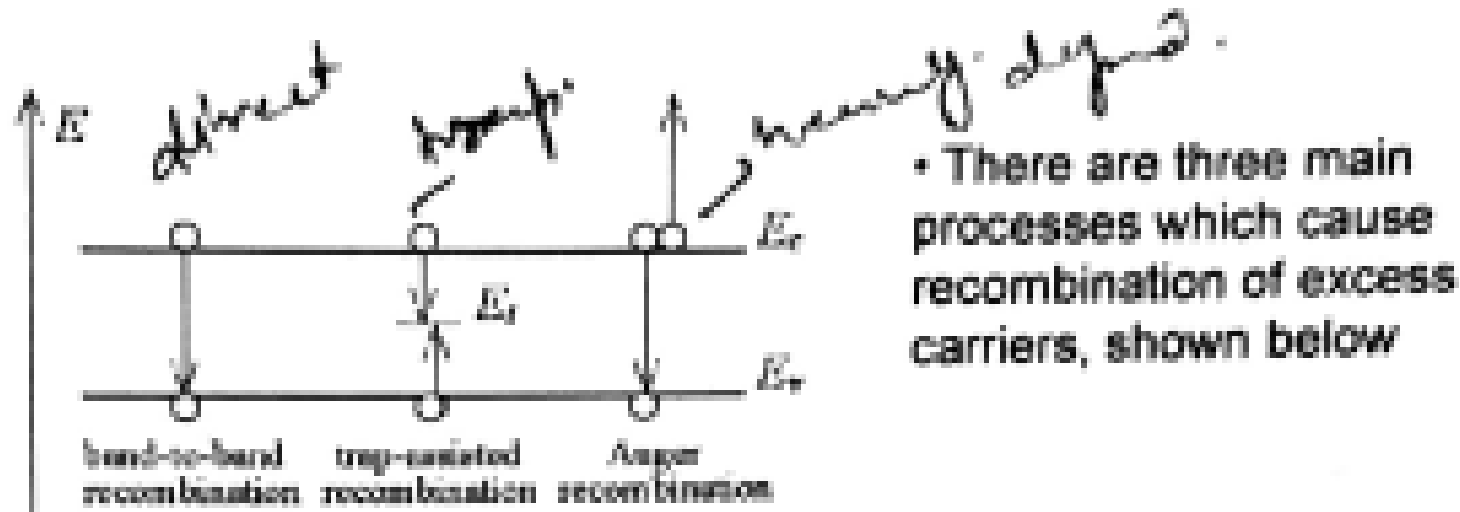

Band to band recombination

- Reverse of absorption, a photon is emitted
- Recombination rate $U_r = B (np - n_i^2)$
- Very weak in indirect semiconductor
- In most solar cell relatively unimportant mechanism

Auger recombination

- recombination process involving third carrier
- Recombination rate $U_a = C np^2 + D n^2 p$
- Important in material with high doping concentration

Recombination of Carriers (2)

Trap-assisted (or indirect) recombination

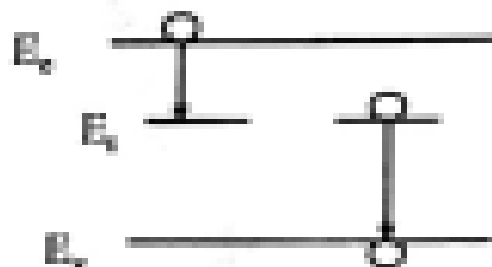

Two step recombination process via trapping level in semiconductor, most dominant process in solar cells

- Dynamics of this recombination process is described by Shockley-Read-Hall (SRH) theory

$$U_T = \frac{np - n_i^2}{\tau_{p0}(n + n_1) + \tau_{n0}(p + p_1)}$$

where the τ 's are the inversely proportional to the number of traps, and are called the *minority carrier lifetimes*

n_1 and p_1 are of the order of n_i

Trap Assisted Recombination

When majority carriers concentration \gg excess carriers \gg minority carrier concentration (low-level injection), then recombination rate R_T can be given as:

$$\text{--- } R_T = \Delta p / \tau_{p0} \text{ in n type material}$$

$$\text{--- } R_T = \Delta n / \tau_{n0} \text{ in p type material}$$

• Surfaces typically contain a large number of recombination centers and affects device performance, this is characterized by **surface recombination velocity, S**

$$R_T = S_{n0} \Delta n \text{ in n type}$$

$$R_T = S_{p0} \Delta p \text{ in p type}$$

The Continuity Equation

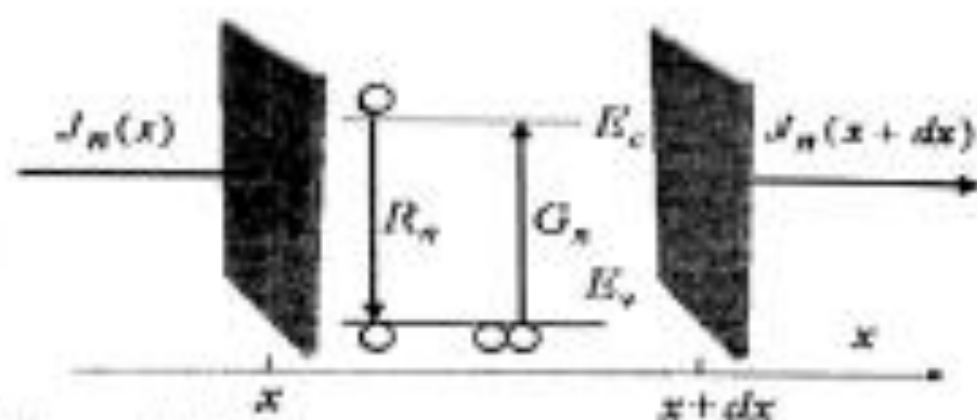

The rate of electron build up

= divergence of current flow + generation rate – recombination rate

$$\frac{\partial \delta n}{\partial t} = \frac{1}{q} \frac{\partial J_n}{\partial x} + G - \frac{\delta n}{\tau_n}$$

This is the continuity equation
for electron

(a similar equation can be
written for the holes)

Minority carrier diffusion equation

Assumption

- analysis limited to minority carriers
- $E = 0$ in the region of analysis
- low level injection
- uniform doping.

If $E = 0 \rightarrow J_n$ (drift) = 0

↓ Only diffusion current of component

Now we know from the diffusion theory

$$J_n = qD_n \frac{dn}{dx}$$

$$\therefore \frac{\partial \delta n}{\partial t} = \frac{1}{q} \frac{\partial J_n}{\partial x} - \frac{\delta n}{\tau_n} + G$$

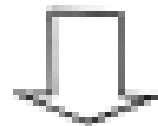

$$\frac{\partial \delta n}{\partial t} = D_n \frac{\partial^2 \delta n}{\partial x^2} - \frac{\delta n}{\tau_n}$$

(if $G = 0$)

- This is known as *diffusion equation*.
- Very useful to solve the problems when excess carriers move in semiconductor through diffusion and disappear through recombination

p-n Junction

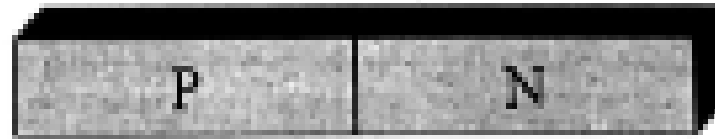

P-type: Doped with N_A/cm^3 acceptor atoms

N-type: Doped with N_D/cm^3 donor atoms

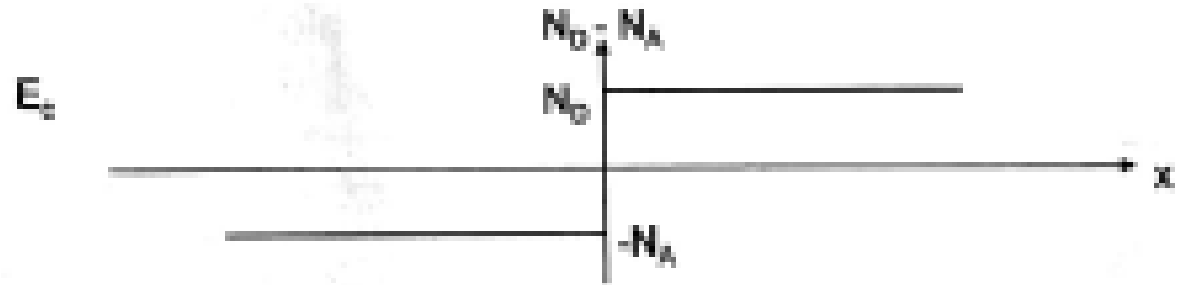

In reality the profile of doping is not abrupt

(Gaussian or Error function profile of dopant)

Energy band diagram of the semiconductor, when they are separated

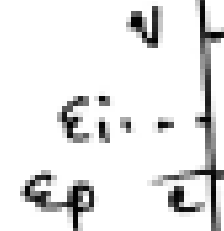
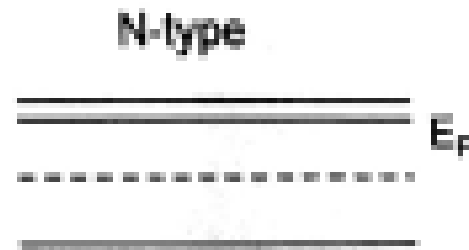
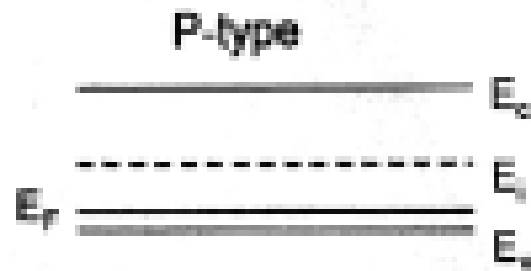

Solar Cell I-V Curve

Solar cell parameters

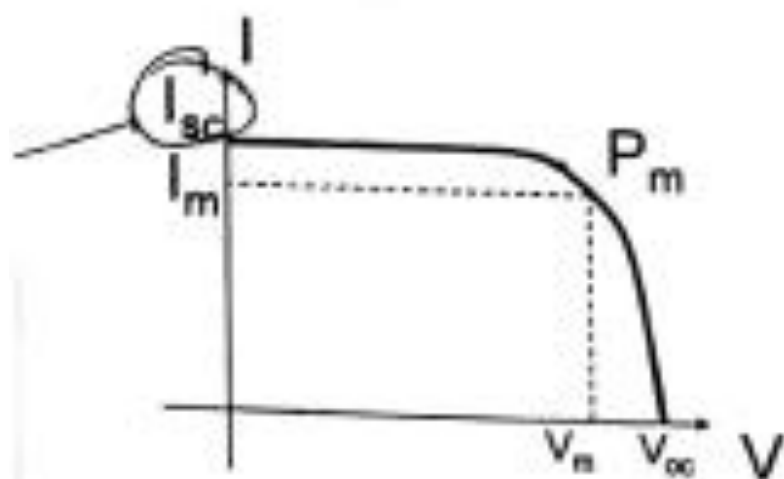

- V_{oc} - open circuit voltage,
- I_{sc} - short circuit current,
- P_m - maximum power point
- I_m, V_m - current and voltage at maximum power point
- FF - Fill factor
- η - Efficiency
- R_s - series resistance
- R_{sh} - shunt resistance

Usual I-V plot of solar cell - Current is shown on positive y-axis

open-circuit voltage
I_{sc}

Max. power w
ro b p

Short-Circuit Current, I_{sc}

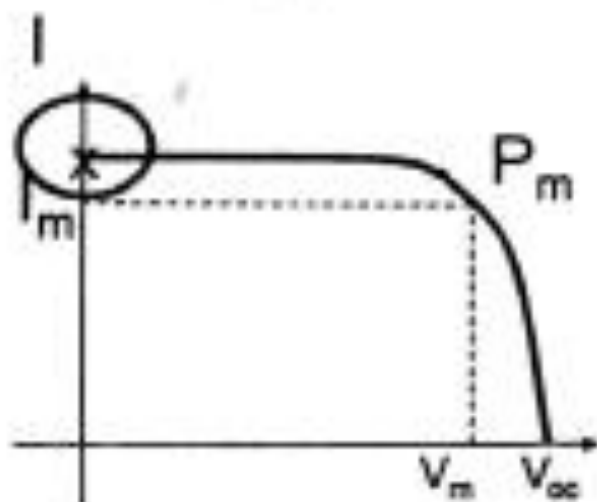

The short-circuit current is the current through the solar cell when the voltage across the solar cell is zero (i.e., when the solar cell is short circuited).

The short-circuit current is due to the generation and collection of light-generated carriers.

The short-circuit current is the largest current which may be drawn from the solar cell.

$$\text{At } V=0 \rightarrow I_{\text{total}} = -I_L = I_{sc}$$

Open Circuit Voltage: V_{oc}

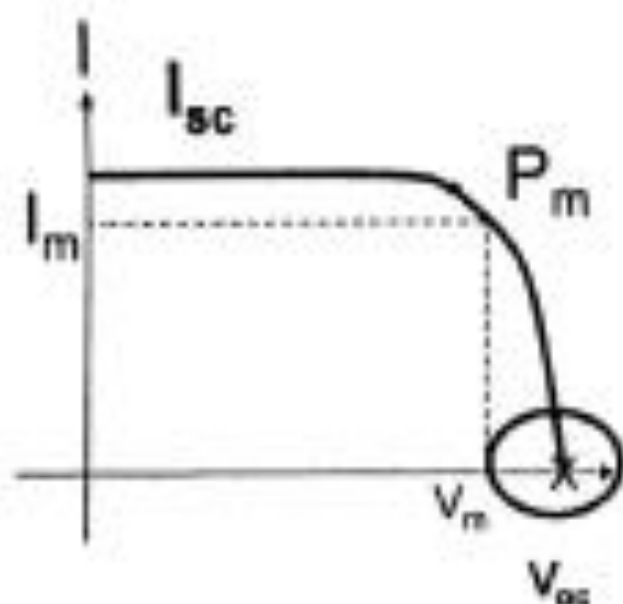

The open-circuit voltage, V_{oc} , is the maximum voltage available from a solar cell, and this occurs at zero current.

The open-circuit voltage corresponds to the amount of forward bias on the solar cell junction due to illumination.

$$V_{oc} = \frac{kT}{q} \ln\left(\frac{I_{sc}}{I_0} + 1\right)$$

Maximum power: P_m

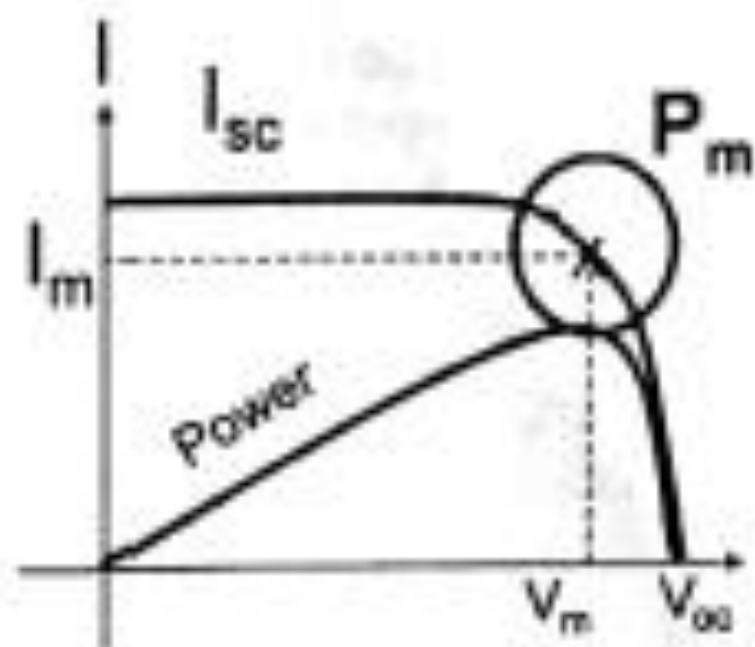

Power out of a solar cell increases with voltage, reaches a maximum (P_m) and then decreases again.

$$P_m = I_m \times V_m$$

Fill Factor: FF

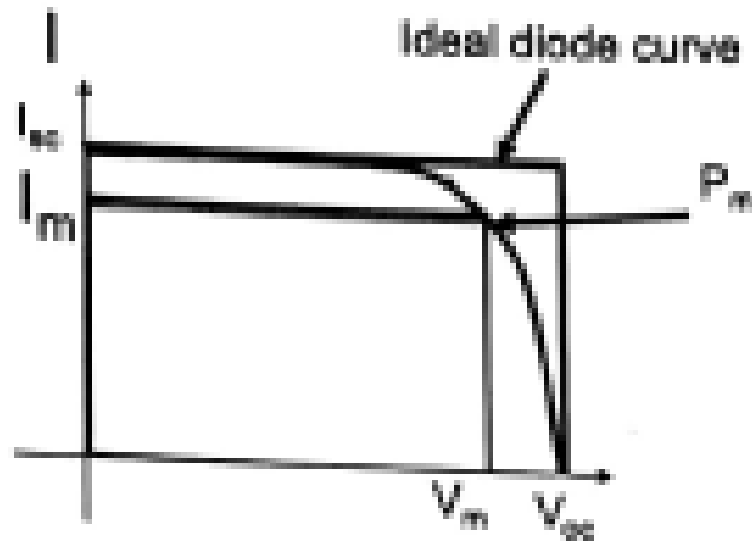

The FF is defined as the ratio of the maximum power from the actual solar cell to the maximum power from an ideal solar cell

Graphically, the FF is a measure of the "squareness" of the solar cell

$$FF = \frac{\text{Max power from real cell}}{\text{Max power from ideal cell}} = \frac{V_m I_m}{V_{oc} I_{sc}}$$

Efficiency η

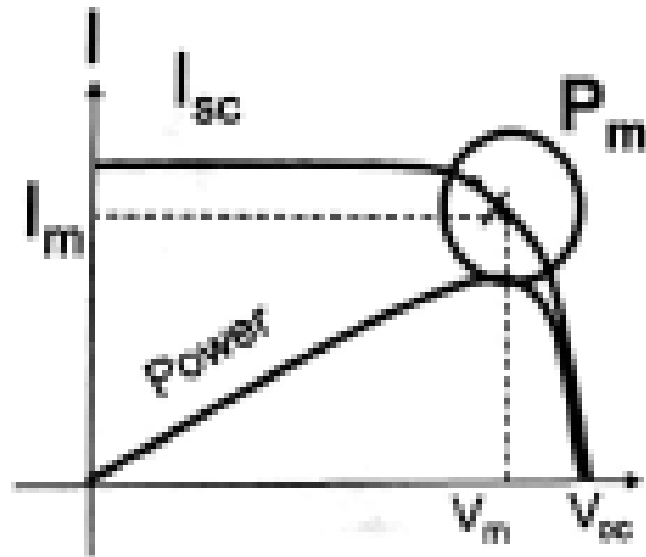

Efficiency is defined as the ratio of energy output from the solar cell to input energy from the sun.

$$\eta = \frac{V_{oc} I_{sc} FF}{P_{in}}$$

The efficiency is the most commonly used parameter to compare the performance of one solar cell to another.

Efficiency of a cell also depends on the solar spectrum, intensity of sunlight and the temperature of the solar cell.

